



Hall Technologies • 1234 Lakeshore Dr Suite #150 Coppell, TX 75019 • halltechav.com

HT-CALIPSO

All-in-one Meeting Collaboration Bar

USER MANUAL

March 20, 2023



Table of Contents

Introduction.....	3
Overview	3
Features.....	3
Package Contents	4
Panel Description.....	5
Installation	7
Application Wiring.....	8
Application 1.....	9
Application 2.....	10
Bluetooth Pairing.....	11
Control – Remote Control.....	12
Key Functions	13
Screen Mirroring.....	13
Using Airplay	13
Using SmartView	14
Using Miracast	14
Using HT-VOYAGER.....	16
Guide Screen	17
OSD.....	18
Soft Codec Support.....	19
Google Meet.....	19
Microsoft Teams	21
Zoom.....	22
Web GUI	24
Camera Page.....	26
Tracking Mode: Off	27
Tracking Mode: Auto Framing.....	28
Tracking Mode: Speaker Tracking	29
Tracking Mode: Presenter Tracking.....	30
Settings Page	31
General Settings.....	31
Video Settings.....	32
WiFi Settings	33
BYOD Settings	34
System Settings.....	35
Support Page	36
Device Info and Firmware Update	36
API Command List	36
Troubleshooting	37
Specifications.....	38

Introduction

OVERVIEW

The HT-CALIPSO is an all-in-one meeting collaboration video bar with an ultra-wide angle 4K AI camera, microphone and speaker features and wireless screen presentation capability. It includes a built-in Wi-Fi module and offers multiple connection options, including AirPlay, Miracast, Smart View, HT-VOYAGER and physical HDMI and USB-C ports. Connecting to the HT-CALIPSO using any of these methods can project the video from the connected device to the connected display.

The HT-CALIPSO includes multiple features such as camera auto tracking, speaker tracking, presenter tracking, Guide Screen, and OSD display. It is ideal for applications in huddle, small, and medium-sized rooms.

FEATURES

- Smart video conference collaboration bar with an all-in-one solution of video, speakers, microphone, and camera.
- Wired screen presentation via USB-C (with DisplayPort) and HDMI.
- Wireless BYOD via AirPlay, Miracast, and HT-VOYAGER (sold separately).
- Wide angle 4K video camera with 120° FOV.
- 4 x MEMS (micro-electromechanical system) digital microphone arrays with a range of 16~26 feet (5~8 meters) and an angle of 180°.
- 2 x 5W Stereo full range speakers with passive radiator bass enhancement.
- Includes AEC (Acoustic Echo Cancellation), AGC (Automatic Gain Control), ANS (Automatic Noise Suppression) and full duplex mode communication to make all participants feel like they are in the same room.
- Built-in AI technology on the camera allowing for Auto Framing, Speaker Tracking, and Presenter Tracking.
- Simple plug and play UCC with excellent compatibility for OS and UC applications, such as Zoom, Teams, Webex, etc.
- Provides flexible control options using Web GUI, the included Remote Controller, and using API commands.
- Built-in Wi-Fi for wireless video casting.

Package Contents

- 1 x Video Bar
- 1 x DC 24V Power Adapter
- 1 x Remote Controller
- 1 x Magnetic Lens Cap
- 1 x Wall-mounted Bracket
- 1 x Wall Hanging Bracket
- 4 x Expansion Screws
- 4 x Mounting Screws

Panel Description

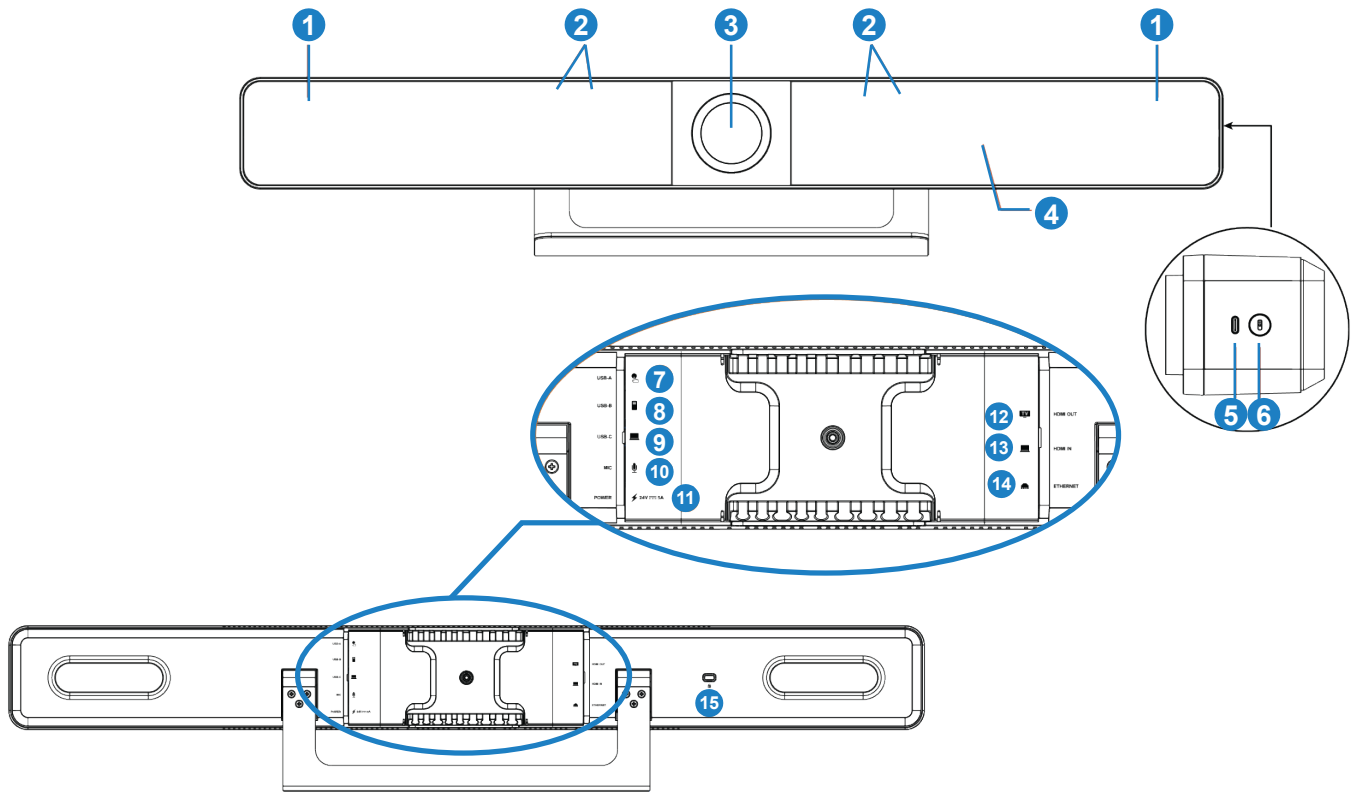

ID	Name	Description
1	Speaker	2 x Speakers for audio signal output.
2	Microphone	4 x Linear microphone arrays for picking up sound.
3	Lens	Camera lens.
4	Status LED	<ul style="list-style-type: none"> LED lighting is orange and blinking: The device is booting. LED lighting is solid white: The device is working properly. LED lighting is white and blinking: The device is in standby mode. LED lighting is white and blinking fast: The device is being upgraded. LED lighting is white and blinking slowly: The device is in sleep mode. LED lighting is red: The device's microphone is muted. LED lighting is blue and blinking: The device is in Bluetooth pairing state.
5	USB-C	Connect to the HT-VOYAGER for pairing.
6	Pairing Button / Factory Reset	<ul style="list-style-type: none"> Pairing: Press and hold this button for more than 2 seconds to pair the included Bluetooth Remote Control. Factory Reset: clicking this button 5 times quickly in succession will reset the HT-CALIPSO to its default factory settings.
7	USB-A	USB 3.0 Type-A port. Connect to a USB device such as touch screen.

8	USB-B	USB 3.0 Type-B port. Connect to the room PC for soft codec meetings.
9	USB-C	USB 3.0 Type-C port. USB PD: 60W max Connect to the laptop for meetings.
10	MIC	Connect to an external microphone HT-SATELLITE-EXT (sold separately).
11	Power	Connect to the included power adapter for DC 24V 5A input.
12	HDMI Out	Connect to an HDMI display.
13	HDMI In	Connect to an HDMI source.
14	Ethernet	Connect to a network device (e.g., network switch, wireless router, computer, etc.) for AirPlay Mirroring signal input and LAN control (Web GUI & Telnet API).
15		Kensington security slot

Installation

INSTALLATION

Note: Before installation, please ensure the device is disconnected from the power source.

To install the device on the wall:

1. Place the included Wall Hanging Bracket against the wall and, after leveling the bracket, mark the four holes to be drilled. Drill the four holes and insert the sheet rock expansion screws (as needed). Secure the Wall Hanging Bracket to the wall using the mounting screws provided.
2. Remove the included stand from the device by removing the six small screws (three on each side).
3. Replace the included stand with the Wall Mounted Bracket attachment, using the same screws the stand came with.
4. From the top slide in the lip from the Wall Mounted Bracket into the Wall Hanging Bracket.

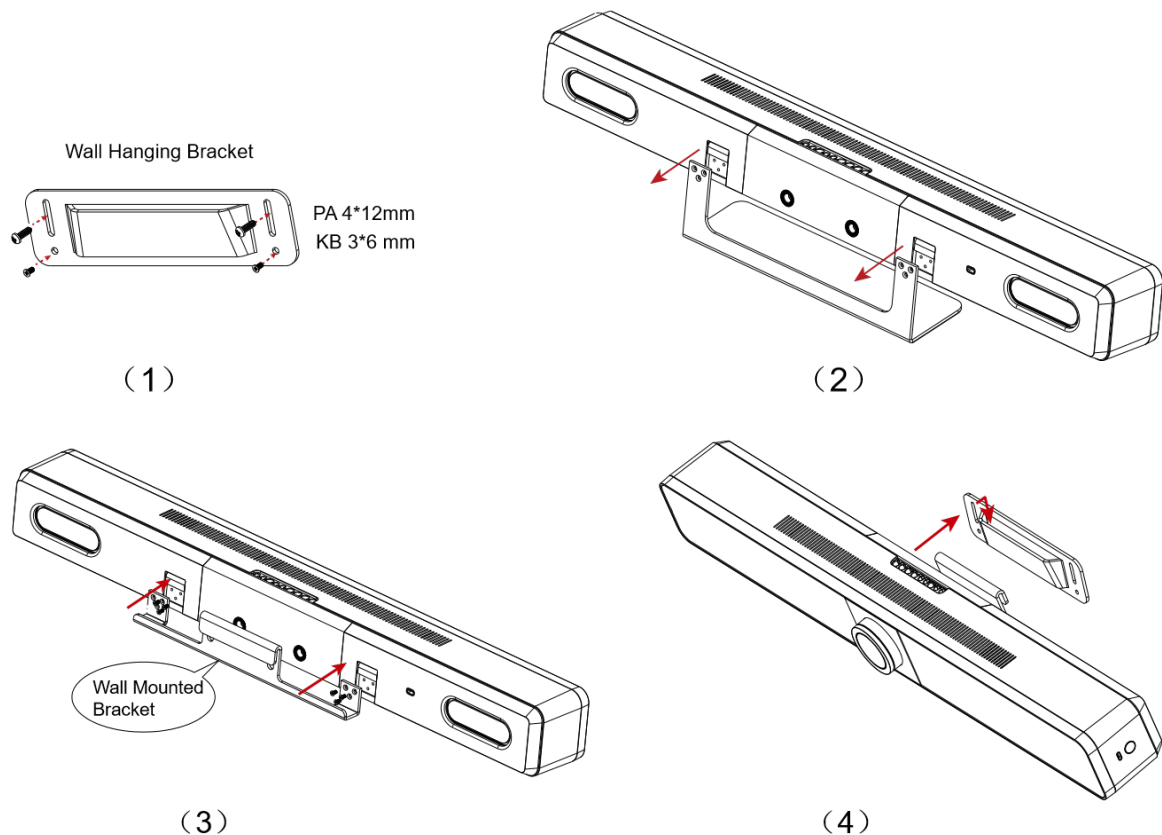

Application Wiring

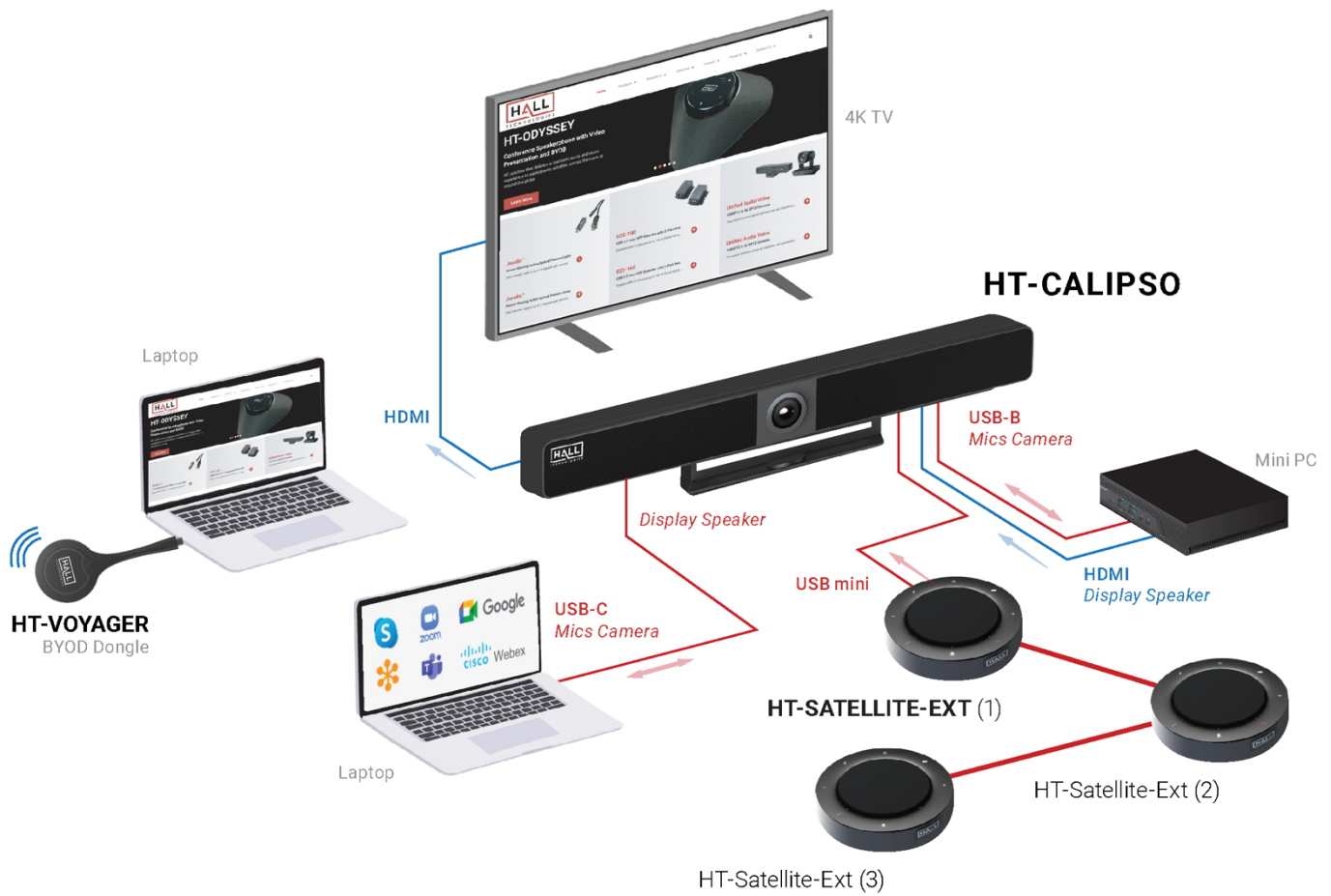

There are two different application methods with wiring examples shown below each.

APPLICATION 1 – BYOM (Bring Your Own Meeting)

This first application for BYOM includes two different methods of wiring, depending on the capabilities of the connected laptop.

The first method can be used if the laptop supports USB Type-C where a single USB Type-C can be used to project video from the connected laptop as well as receive microphone audio and camera video from the HT-CALIPSO. This method supports DP1.4, USB3.0, USB2.0 and PD (max 60W).

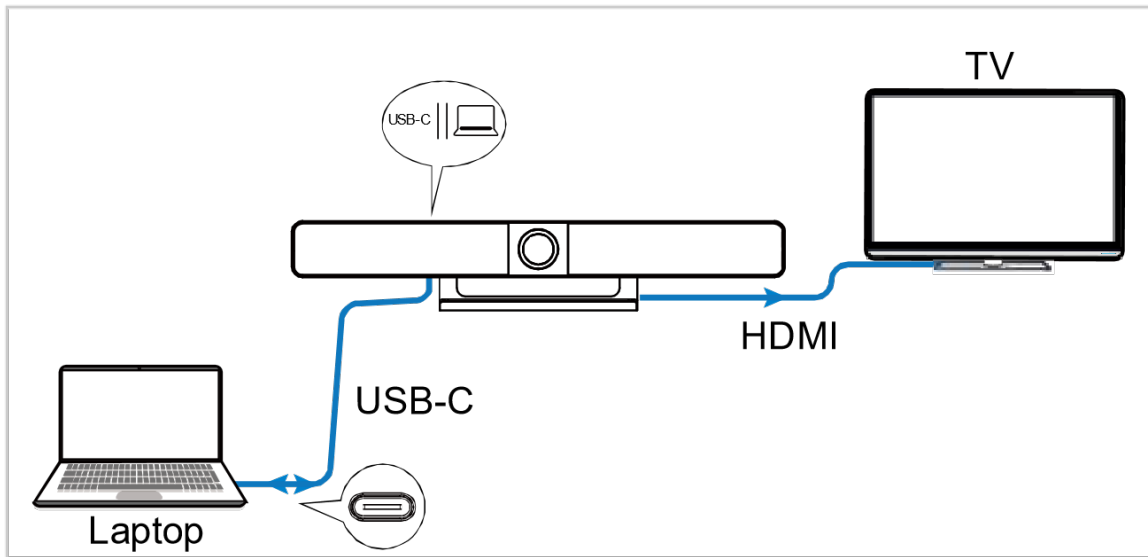

The second method is used if the laptop does not support USB Type-C. In this method both HDMI and USB-A to USB-B cables are needed. The laptop uses the HDMI to project video through the HT-CALIPSO to the connected display and uses the USB-A to USB-B cable for microphone audio and camera video from the HT-CALIPSO.

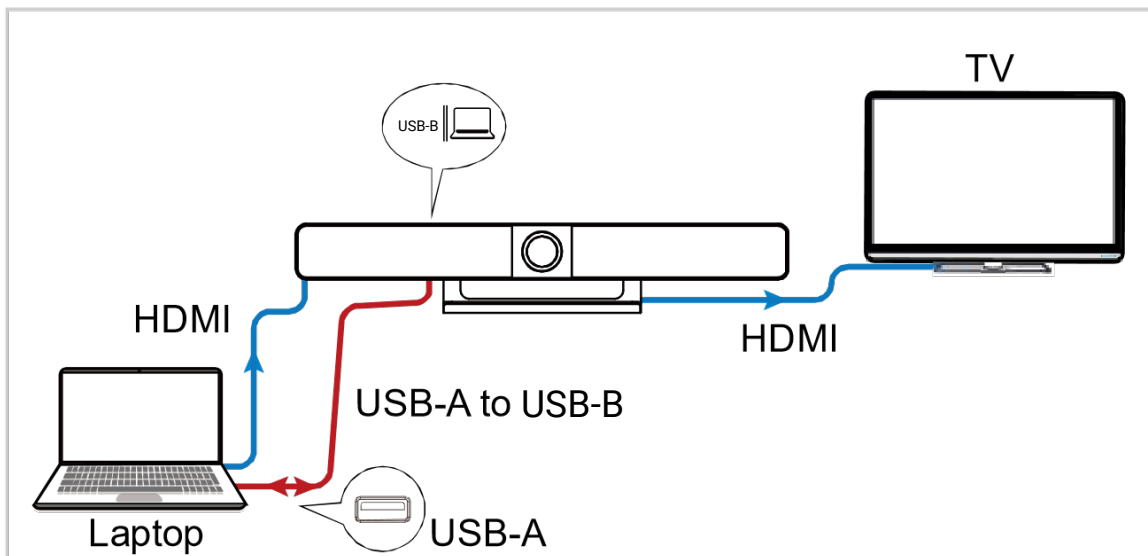

APPLICATION 2 – ZOOM ROOM + BYOM

This second application for BYOM includes integrating the HT-CALIPSO with a Zoom Room PC. This is accomplished by adding a USB Capture device to convert the HDMI video out of the HT-CALIPSO into the Room PC along with a USB cable. In this application the laptop is used as a source into the Room PC through the HT-CALIPSO and the Room PC can view the source along with the camera for Zoom calls.

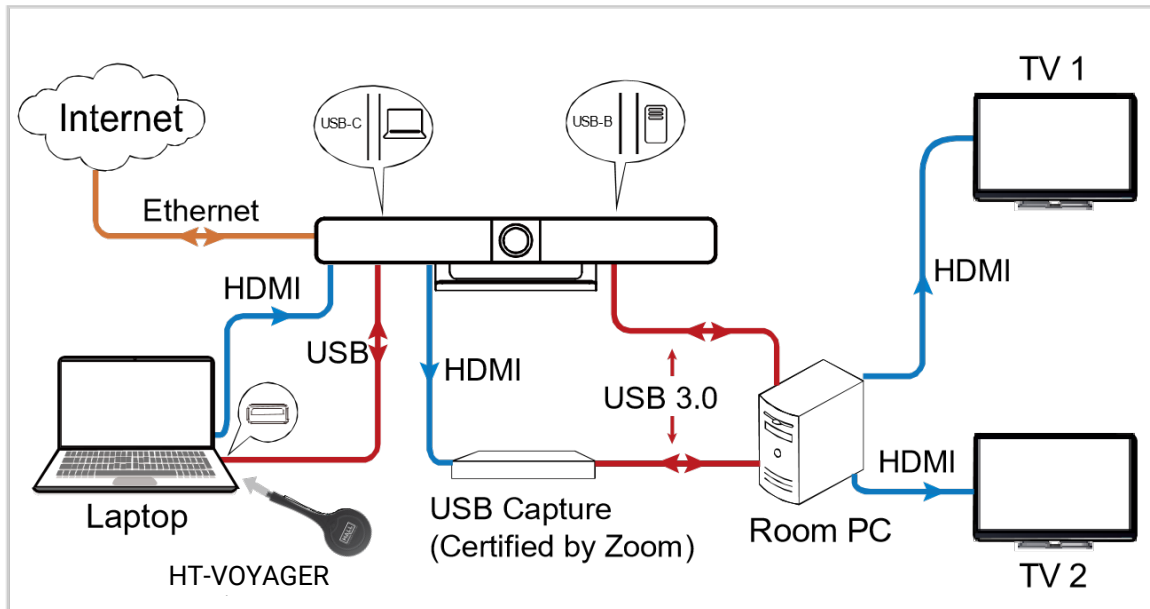

Note: After the HT-CALIPSO is connected to a computer it can be detected by the system using the following names:

Model: **HT-CALIPSO**

Camera/Speaker/Microphone: **HT-CALIPSO-CAM & HT-CALIPSO-SPEAKERPHONE**

Bluetooth Pairing

The device can be controlled using the included Bluetooth remote controller once the two have been paired with each other.

To pair with the Bluetooth remote controller:

1. Press and hold the pairing button  located on the right side (when looking at the front of the HT-CALIPSO). The front LED will blink blue, which indicates that the device is in Bluetooth pairing mode.
2. When the HT-CALIPSO is in pairing mode, press any button on the remote controller. A pop-up on the display will include the sentence “**Remote Control Connected**” indicating that the Bluetooth pairing between the remote controller and the HT-CALIPSO is successful.

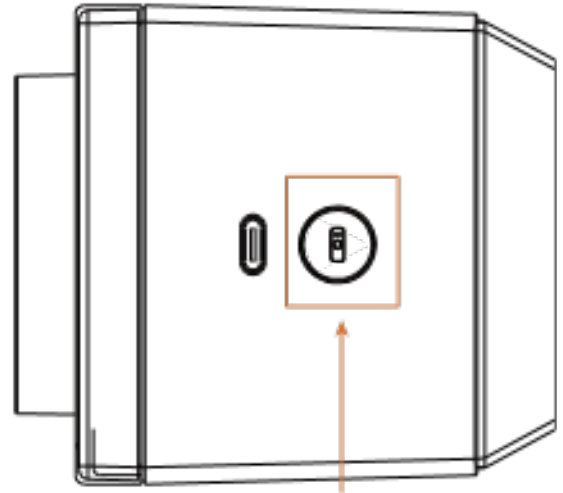

Control – Remote Control

Many camera controls can be accessed using the included remote control.



Remote Element	Description
	Press and hold the remote’s Bluetooth button for 2 seconds to enable the HT-CALIPSO to start pairing with other third-party Bluetooth devices. (This function will be available in future versions.)
	<p>Answer: Press to answer the phone (only available when connected to a cellphone via Bluetooth).</p> <p>Hang Up: Press to hang up the phone (only available when connected to a cellphone via Bluetooth).</p>
	<p>Navigation: Press to perform the ePTZ functions, such as panning, tilting, and zooming (only available when Tracking mode is off).</p> <p>Home:</p> <ul style="list-style-type: none"> Press to return the default camera view to the home view (only available when Tracking mode is off). Press and hold the home button for 2 seconds to show the OSD which includes the IP address, model name, etc. This will be displayed for 10 seconds before disappearing.
	<p>Presets:</p> <ul style="list-style-type: none"> Press and hold 3 seconds to save the current camera view to preset 1 or 2. Press to toggle the camera view to preset 1 or 2. (Only available when Tracking Mode is off.)
	<p>Mute: Press to toggle between microphone mute and unmute.</p>
	<p>Volume:</p> <ul style="list-style-type: none"> Press to up or down to increase or decrease the speaker volume. Press and hold to adjust the volume continuously. <p>Tracking Mode: Press to toggle between Auto Framing, Speaker Tracking, Presenter Tracking, and Manual modes.</p>
	<p>Zoom:</p> <ul style="list-style-type: none"> Press to adjust the zoom in (+) or out (-). Press and hold to adjust the zoom continuously. <p>Press and hold the combination buttons for 3 seconds to pair with a cellphone. (This function will be available in future versions.)</p>

Key Functions

SCREEN MIRRORING

With screen mirroring support, the HT-CALIPSO allows you to share your mobile devices' content wirelessly over AirPlay Mirroring, Miracast, Smart View and HT-VOYAGER. In this manual, mobile devices available for screen mirroring are referred to as "screen mirroring sources", which include Apple devices (iPhone/iPad/Mac), Android phones, Windows PCs, and HT-VOYAGER.

1. Screen mirroring using AirPlay

Using an iPhone 8 (iOS 15.2) for example:

1. Connect your iPhone to the soft AP of the device.
2. **Soft AP SSID:** this should be the same as the device name which can be obtained from the OSD at the upper right corner of the display screen. By default, it is set as **HT-CALIPSO**.
3. **Password:** this password can be set through Web UI or Telnet API and can be obtained from the OSD at the bottom right corner of the display screen. By default, it is set as **12345678**.
4. Slide up from the bottom of the iPhone's screen to show the control center. Click **Screen Mirroring** and choose the device name in the pop-up list.
5. HT-CALIPSO now displays your iPhone's screen.
6. To disconnect iPhone from the device: click Stop Mirroring. The display stops displaying your iPhone's screen.

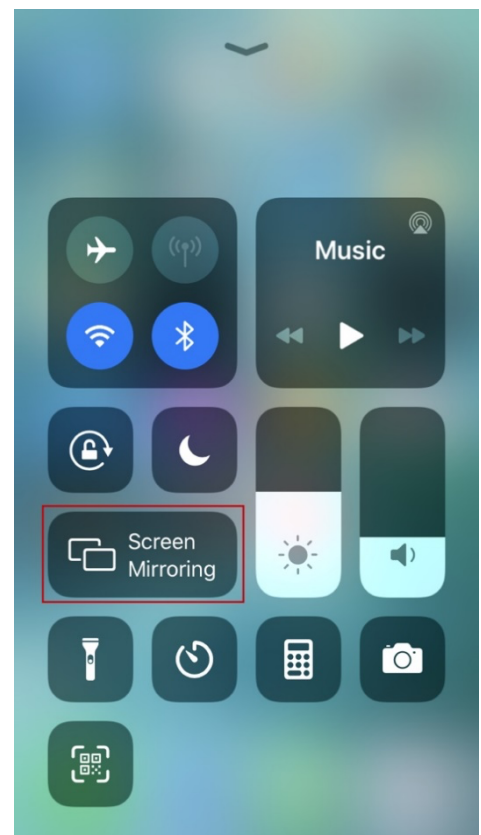

2. Screen mirroring using Smart View

For Android mobile (using Samsung Galaxy S9 for example):

1. Enable the Wi-Fi or WLAN feature of the mobile.
2. Slide down from the top of the screen and click the **Smart View** icon in the pop-up interface.
3. The Smart View window appears and starts to search for Miracast receiver. Click the HT-CALIPSO device name in the search result and the device will output the mobile screen.

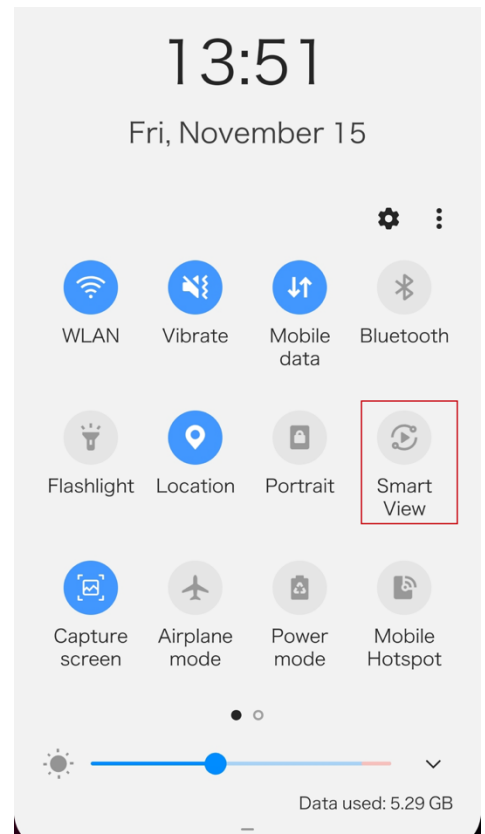

3. Screen mirroring using Miracast

For Windows 10 PC:

1. Enable the WLAN feature of your PC.
2. Click the icon on bottom right of the screen to open **Action Center**.



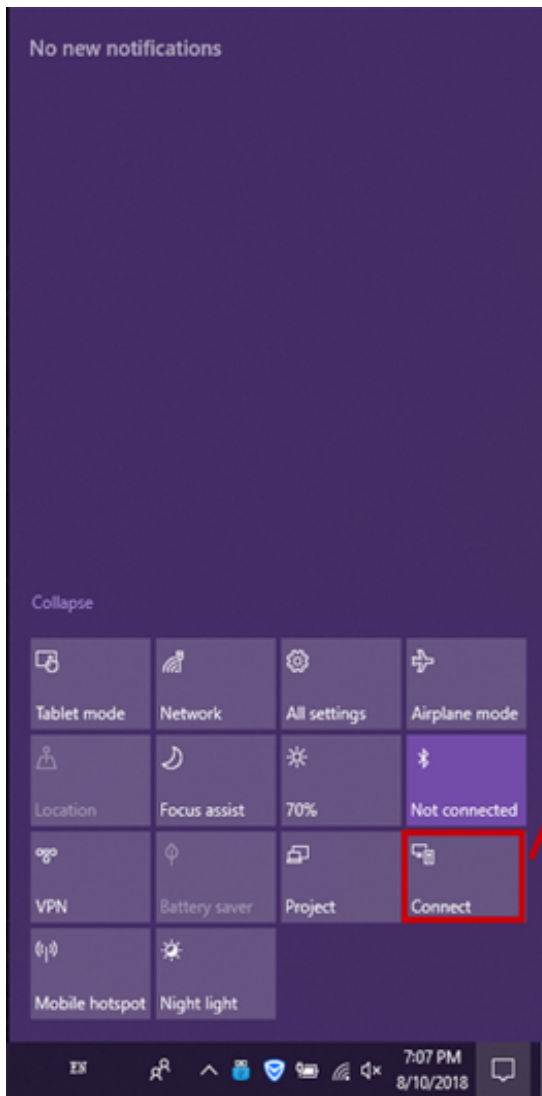

3. Click **Connect**.
4. Click the HT-CALIPSO device name in the search results.
5. The HT-CALIPSO device displays the PC's content once your PC is connected to the device successfully.
6. To disconnect PC from the device: click **Disconnect**.



Note:

- The icon and interface of the Miracast function may vary on different computers.
- Some Windows 10 computers may fail to perform screen mirroring with Miracast due to compatibility issues.

Tip: Both the AirPlay mirroring and Miracast support access code. If you see the PIN entry window appears on your devices, input the access code which can be obtained through OSD. (See "[OSD](#)" section for more information.)

4. Screen mirroring using HT-VOYAGER

HT-VOYAGER allows you to share your laptop's content on the display screen without installing any additional software. Simply plug in the HT-VOYAGER into USB-C and click the button. For more information, see the user guide of HT-VOYAGER.

Steps to share laptop's screen on the display using HT-VOYAGER:

1. Pair the HT-VOYAGER with HT-CALIPSO.

Connect the HT-VOYAGER to the PAIRING port of the HT-CALIPSO for pairing. Once pairing is completed, "Pairing successful" appears on the display screen. (This will take around 20 seconds to complete.)

2. Connect the HT-VOYAGER to a laptop.

The HT-VOYAGER will start running when connected into a laptop and will automatically connect to the switcher's soft AP. Once the HT-VOYAGER connects to the HT-CALIPSO successfully, the HT-VOYAGER LED stops blinking and will be solid white.

3. To mirror the laptop, press the HT-VOYAGER's projecting button. To display the laptop's screen in full screen, press and hold the button for at least 5 seconds.

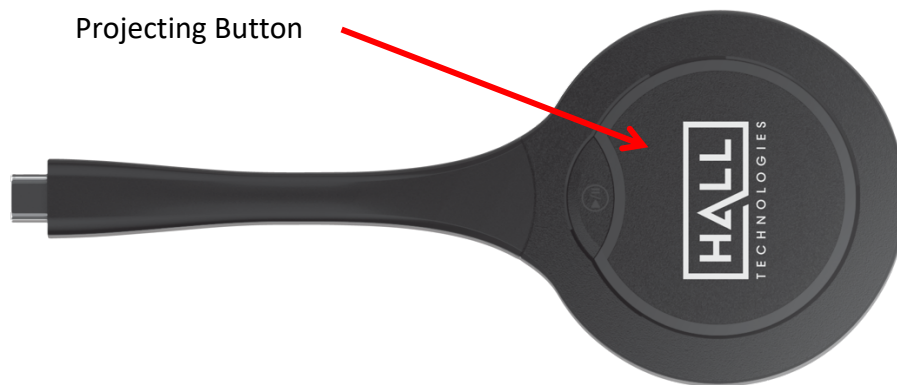

Note: For more information about HT-VOYAGER, see the HT-VOYAGER user guide.

GUIDE SCREEN

The device uses a Guide Screen to convey the basic connection instructions for users. The Guide Screen can be personalized to allow custom connection instructions on the device's Web UI page.

When all video sources are disconnected from the device, the following Guide Screen appears on the display screen automatically:

Guide

Apple

Step One On your iPhone or iPad, slide down the screen from the battery icon to show the Control Center.
On your Mac, click the control center icon at the top of the screen.

Step Two Select the Screen Mirroring icon and Select the appropriate casting device.

Android

Step One On your Android phone or tablet, slide down the screen from the top to show the dashboard.

Step Two Select the Smart View icon or Screen Cast icon and Select the appropriate casting device.

Windows

Step One On your Windows PC, Press the Win + K to show the cast menu.

Step Two Select the appropriate casting device.

DONGLE

Step One Plug in the Dongle on PC or Laptop.

Step Two Press the button to start casting.

HT-CALIPSO
No Access Code

IP: 192.168.9.46
WiFi Pwd:12345678

Note:

- This Guide Screen picture can be changed through the Web UI setting. Please refer to [Guide Screen](#) section for more information.
- By default, if the Guide Screen is being displayed for 60 seconds with no wireless casting connectivity, a countdown timer with the time period of 60 seconds will appear.

The Guide Screen is accessible in the following cases:

- Automatic switching: by disconnecting all video sources from the switcher, the Guide Screen appears automatically.
- Manual switching:
 - ➔ Through Web UI page. For more information, see [State & Switch](#) section.
 - ➔ Send API command through telnet to the switcher to show the Guide Screen. For more information, see the separate HT-CALIPSO API documentation.

OSD

The switcher supports OSD (On Screen Display) to convey device basic information, including the video source's information, access code, device name, IP address, and Wi-Fi password. The following is an example of OSD.

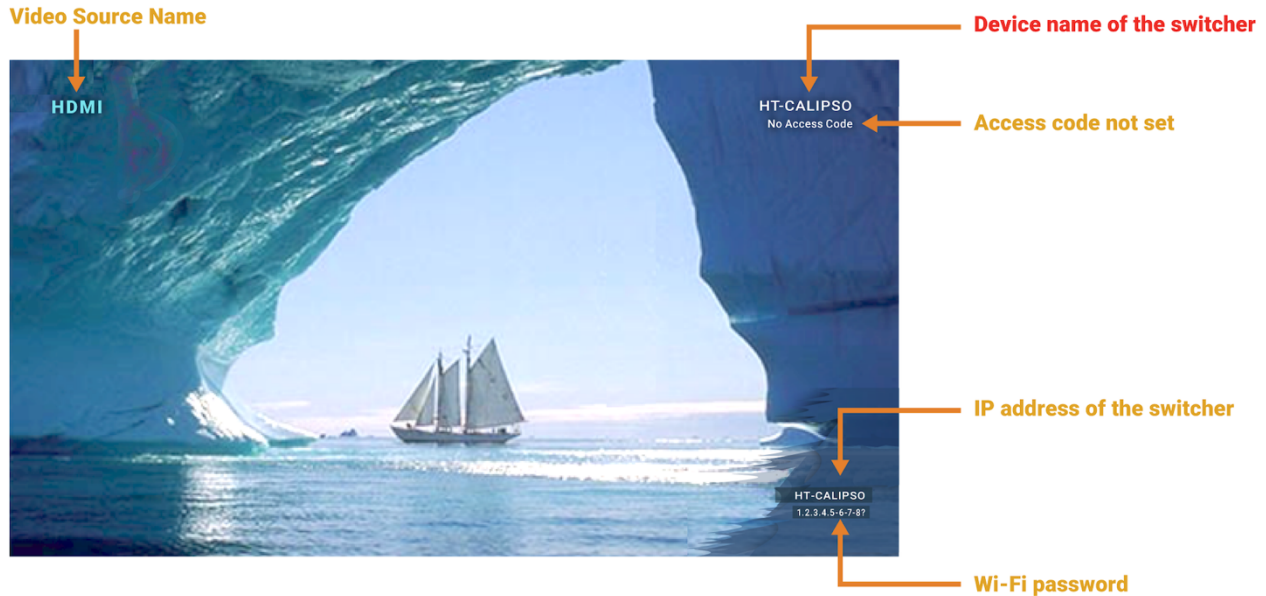

Note:

- When the switcher outputs the Guide Screen, the OSD will be displayed continuously until the countdown timer reaches zero.
- When the device outputs video input sources, the OSD will be displayed for 10 seconds and then will disappear.
- By default, the access code is set as blank, and therefore the OSD doesn't display the access code. If you want to set access code, please see BYOD section for more information.

Soft Codec Support

The following are instructions to utilizing the HT-CALIPSO camera and microphones in the Google Meet, Microsoft Teams, and Zoom soft codec applications. The HT-CALIPSO is not limited to these three. *(For soft codec applications outside of these three please refer to their user manual.)*

GOOGLE MEET

To use the devices in Google Meet, open “More Options” and then click on “Settings.” In the video settings, select the “HT-CALIPSO-CAM” for the camera and in the audio settings select “HT-CALIPSO-SPEAKERPHONE” for both microphone and speaker.

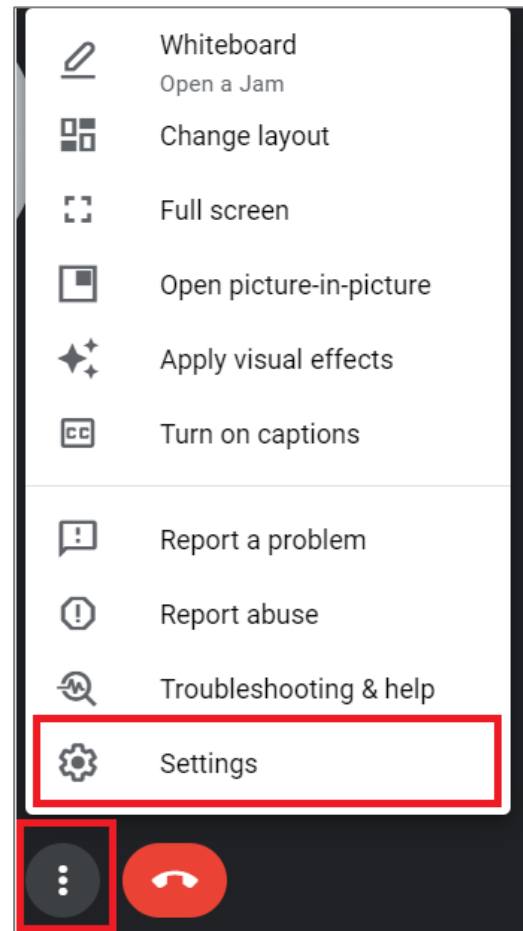

Settings

- Audio
- Video**
- General
- Captions
- Reactions

Camera

HT-CALIPSO-CAM

Adjust video lighting
Makes it easier to see you against a bright background

Send resolution (maximum)
Auto

Receive resolution (maximum)
Auto

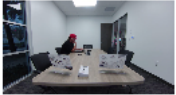

Settings

- Audio**
- Video
- General
- Captions
- Reactions

Microphone





Microphone (2- HT-CALIPSO-SPEAK...)

Push to talk
Press and hold spacebar to unmute your mic

Speakers

Speakers (2- HT-CALIPSO-SPEAKER...)

Call control



Test

MICROSOFT TEAMS

To use the devices in Microsoft Teams, open Device Settings located in the “More” menu. In the video settings, select the “HT-CALIPSO-CAM” for the camera and in the audio settings select “HT-CALIPSO-SPEAKERPHONE” for both microphone and speaker.

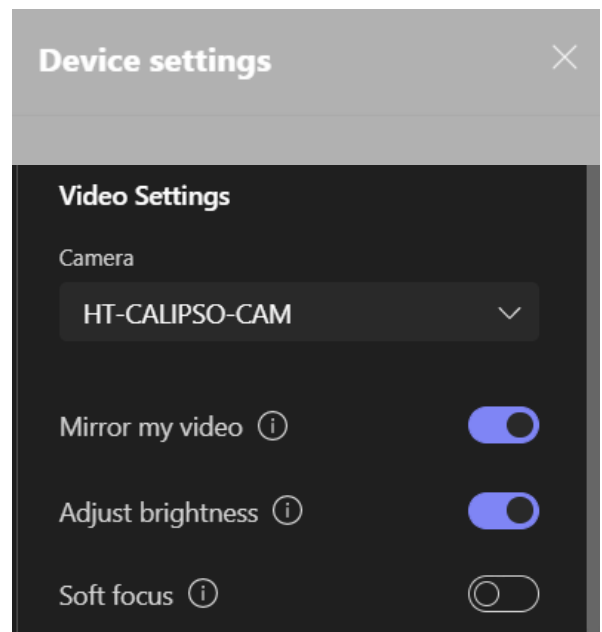
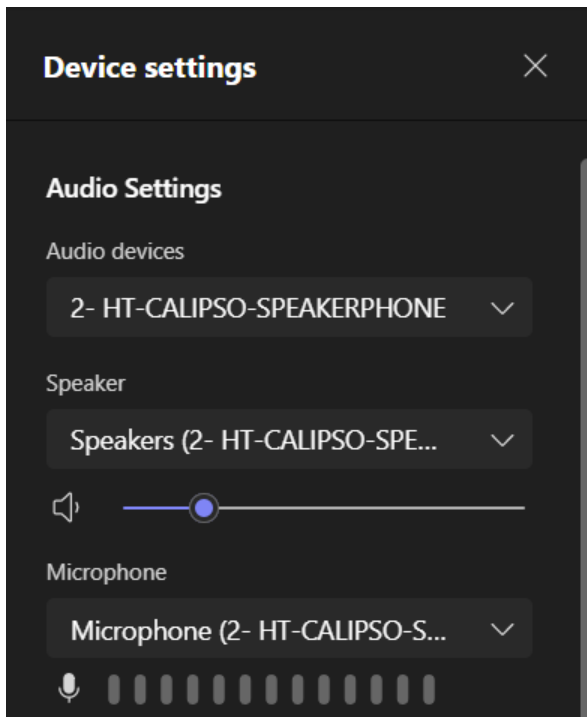
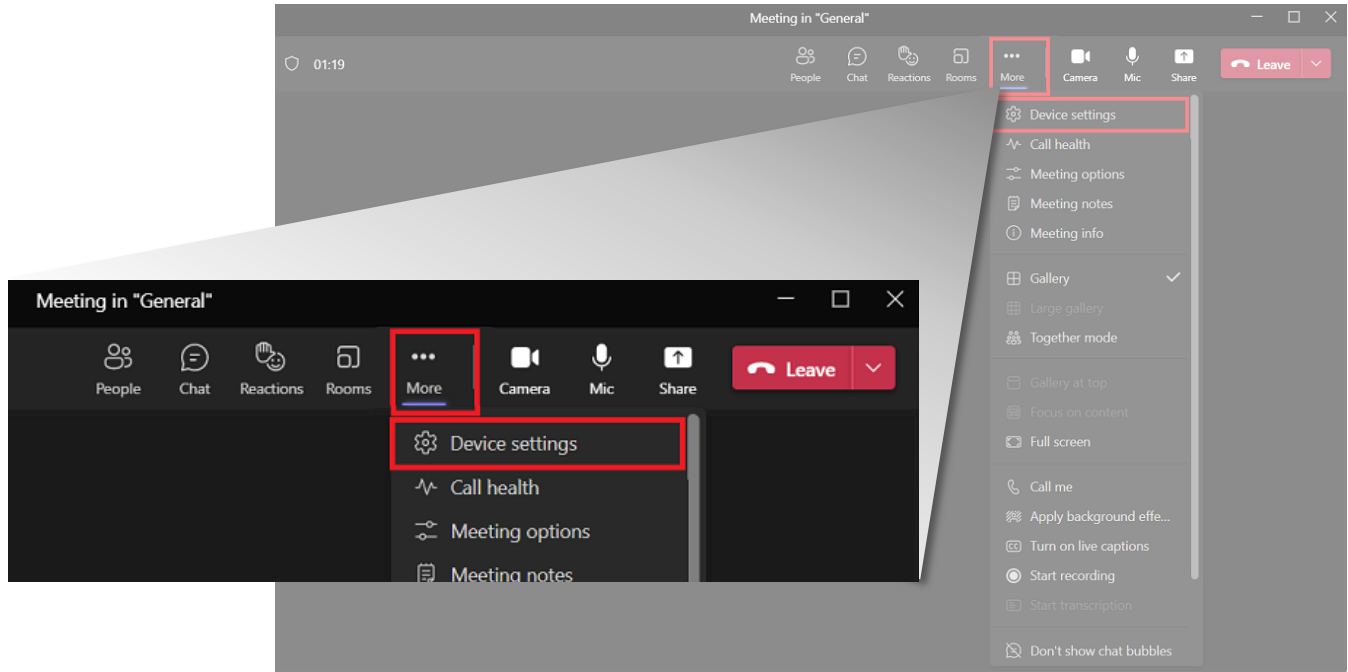

ZOOM

To use the devices in Zoom, click on the “up” arrow on the microphone and camera buttons located on the bottom left part of the Zoom screen. In the video settings, select the “HT-CALIPSO-CAM” for the camera and in the audio settings select “HT-CALIPSO-SPEAKERPHONE” for both microphone and speaker.

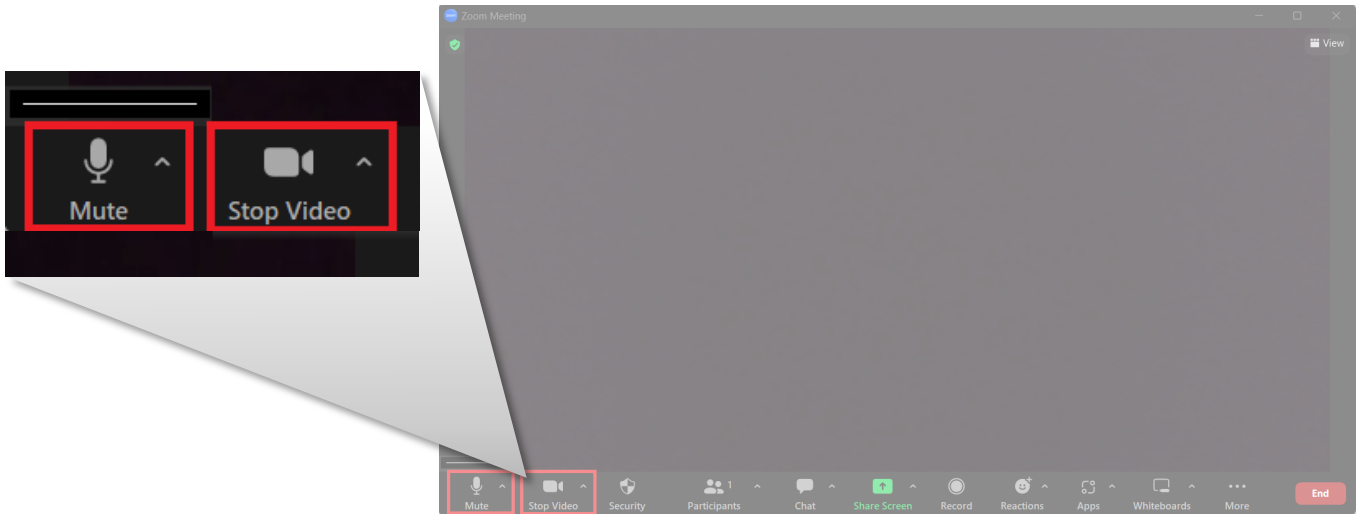

VIDEO

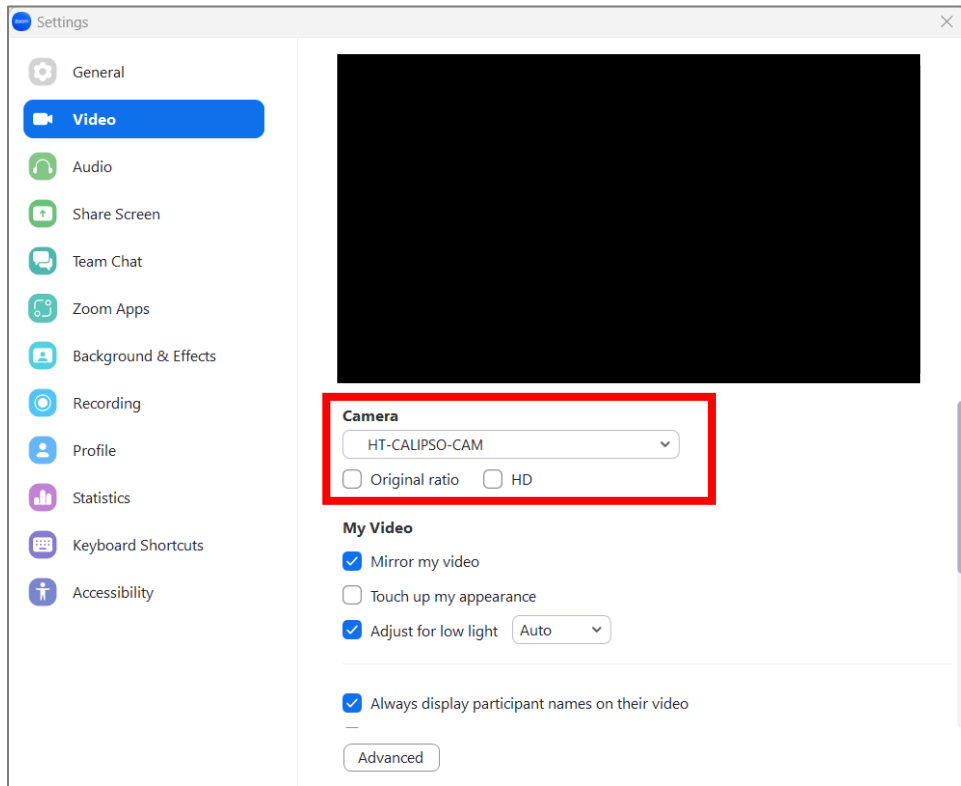

AUDIO

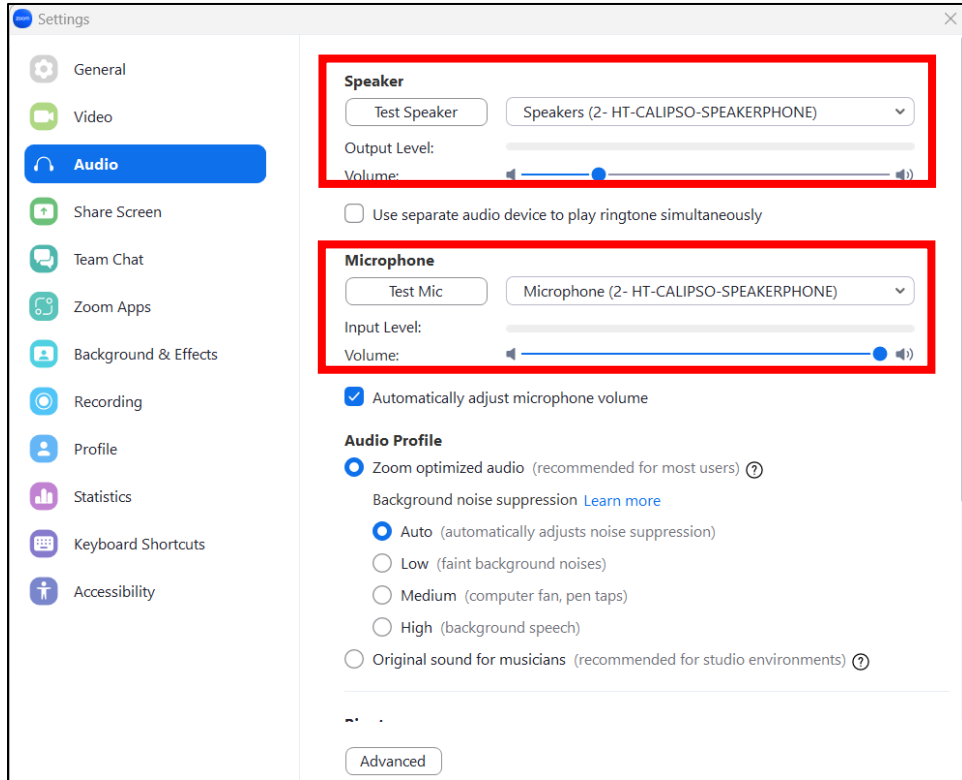

Web GUI

The Web UI designed for the HT-CALIPSO allows for basic controls and device settings. This Web UI can be accessed through a modern browser, e.g., Chrome, Safari, Firefox, IE10+, etc.

To get access the Web UI:

1. Connect the LAN port of the switcher to a local area network. Ensure there's a DHCP server in the network so that the device can obtain a valid IP address. (If there is no DHCP server the video bar will revert to a 169.254.x.x address which you can find on the OSD. Use this to change the video bar IP to a static IP address and set your own.)
2. Connect the PC to the same network as the video bar.
3. Input the video bar's IP address in the browser and press Enter, the following window pops up. (See [OSD](#) section to easily view the IP address)

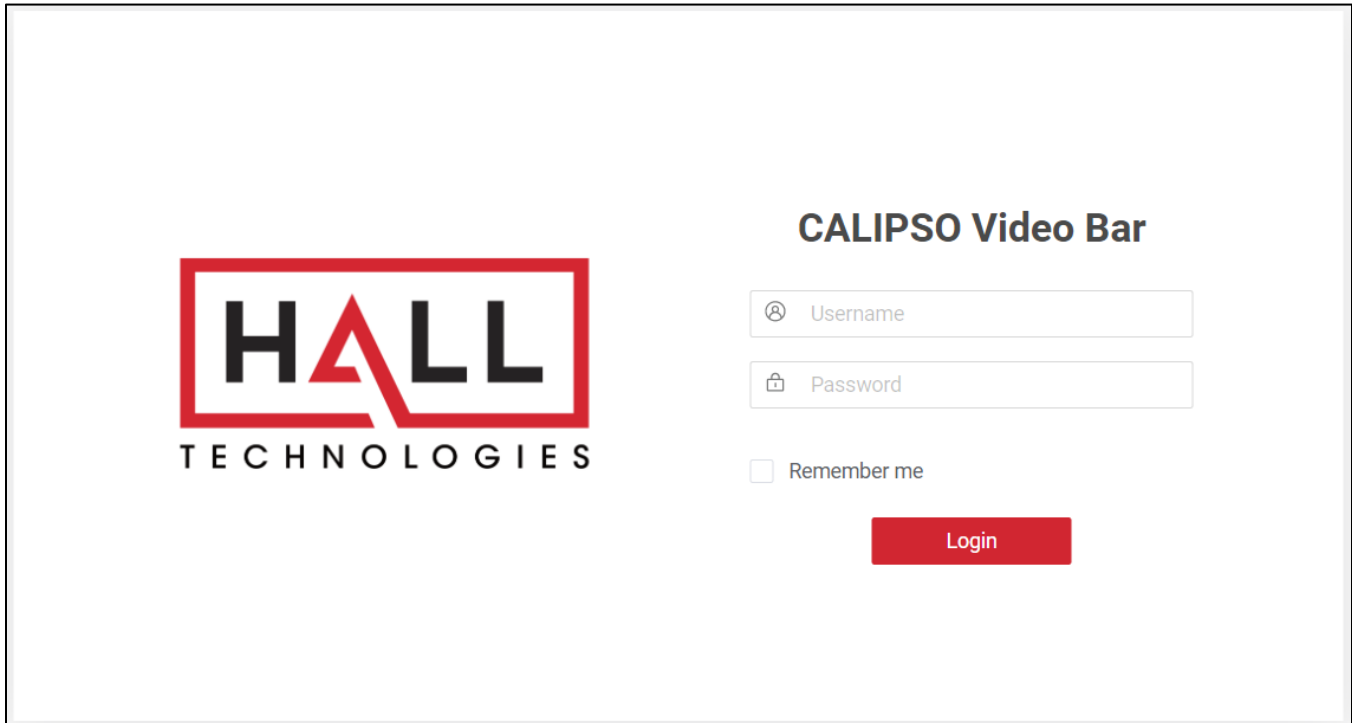

HALL
TECHNOLOGIES

CALIPSO Video Bar

Username

Password

Remember me

Login

4. Input the password (default password: **admin**) and click **Login** to enter the main page

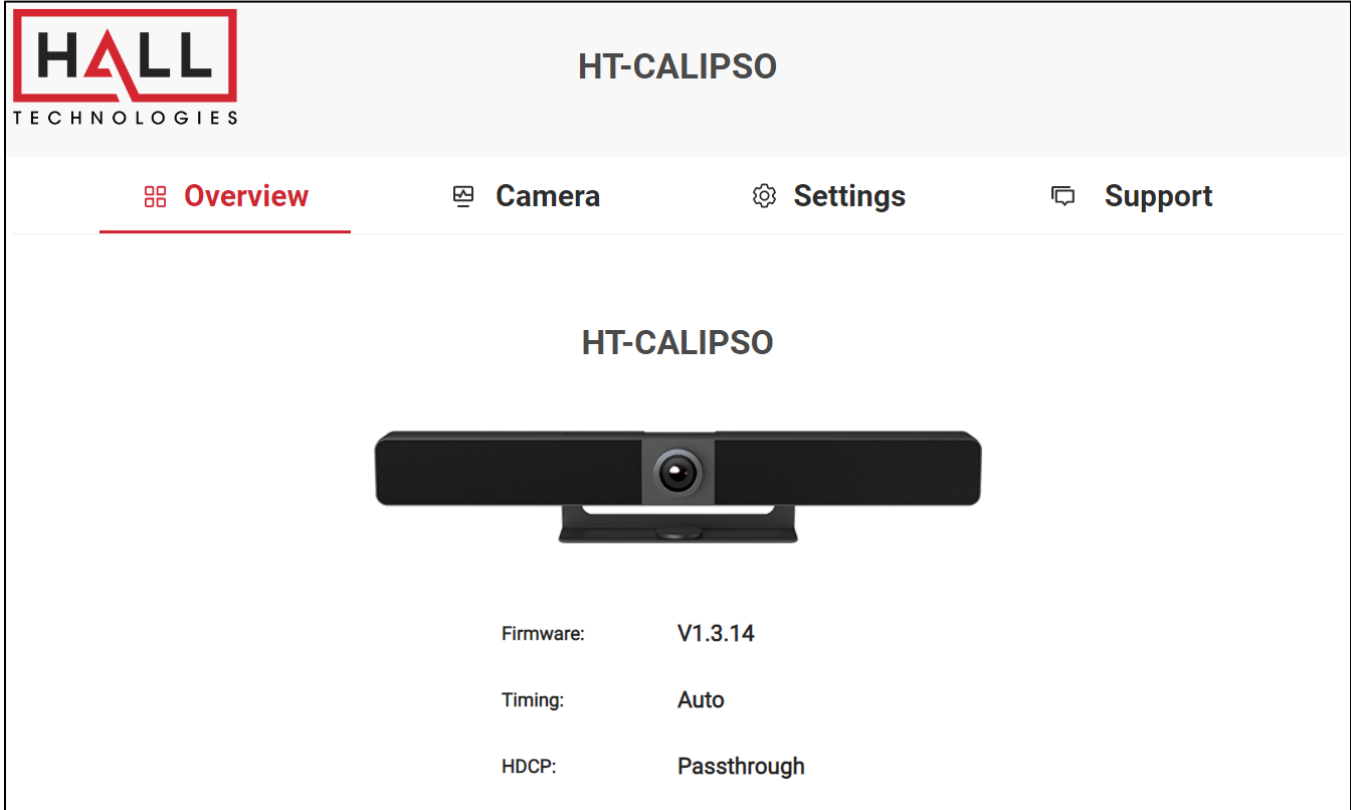

The Web UI main page includes Overview, Camera, Settings and Support Pages.

- **Overview** (1st page) – offers an overview of the HT-CALIPSO including the firmware version, connected source timing, and HDCP setting.
- **Camera** – offers control of the ePTZ camera including setting presets.
- **Settings** – offers settings of network & Wi-Fi, Video, BYOD, Soft AP, System, etc.
- **Support** – offers device information and settings for updating the firmware.

Camera Page

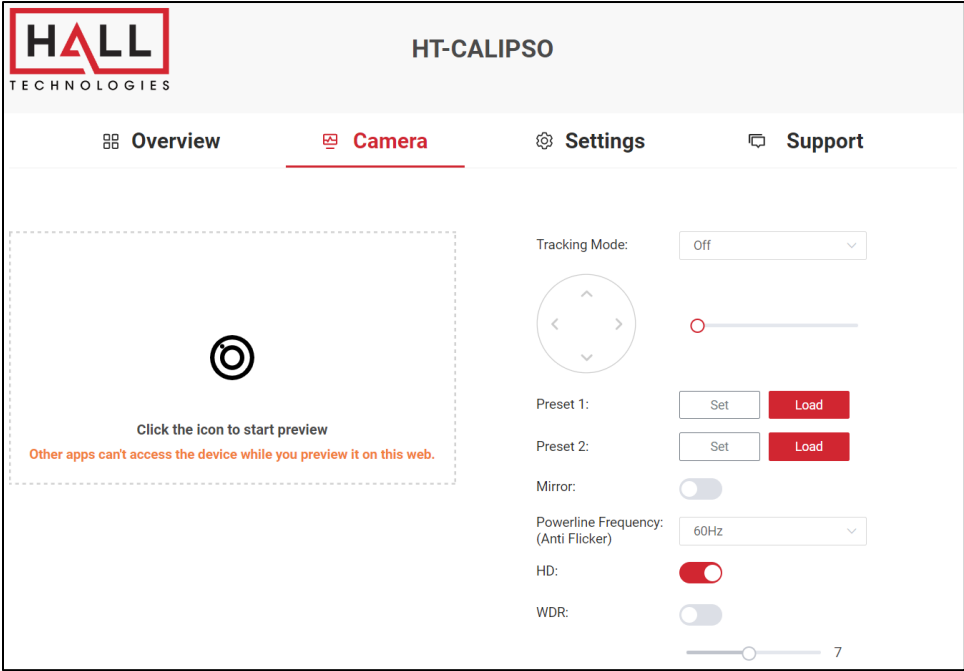

UI Element	Description
Icon Preview	Click the icon to start the preview of the camera.
Tracking Mode	Select the desired tracking mode between Off, Auto Framing, Speaker Tracking, and Presenter Tracking.

TRACKING MODE: OFF

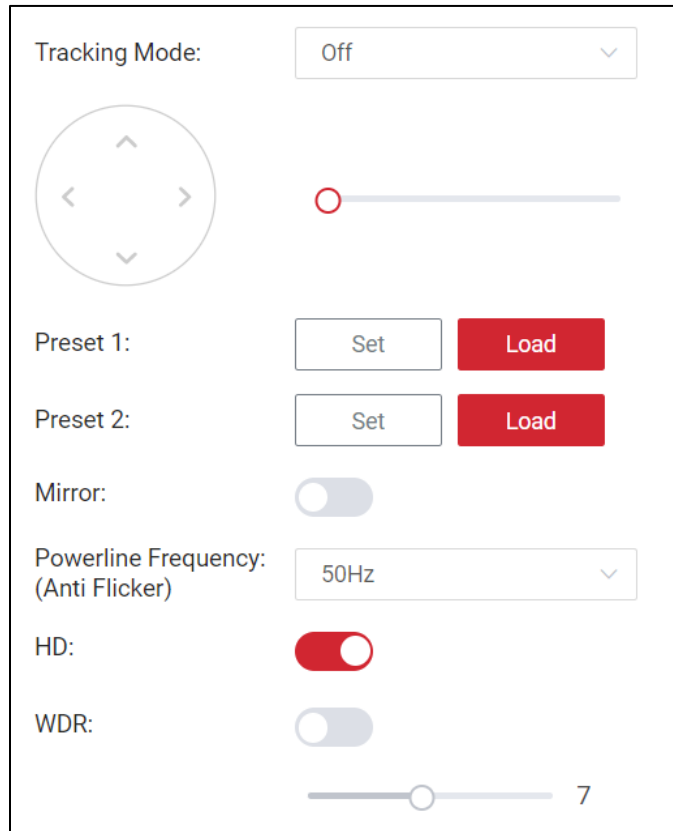

UI Element	Description
Up/Down/Left/Right Arrows	Click up, down, left, or right to pan and tilt the ePTZ camera. Note: the buttons are grayed out if the camera is zoomed out all of the way.
Zoom Bar	Zooms the camera in by moving the circle to the right; and moves the camera back out by moving the circle to the left.
Preset 1, Preset 2	After adjusting the pan, tilt, and zoom, users can store the presets in either Preset 1 or Preset 2 by setting the “Set” button on the desired preset. To recall the preset press “Load”.
Mirror	Mirror flips the camera in the mirrored direction.
Powerline Frequency (Anti Flicker)	If there is flicker in the camera, typically caused by fluorescent light bulbs in the room, change the set frequency to the other one. (Options are 50Hz or 60Hz)
HD	Off decreases the quality of the camera to ensure laptop compatibility; On increases the quality to HD.
WDR	Adjusts wide dynamic range to improve the camera’s image quality under high-contrast lighting conditions.

TRACKING MODE: AUTO FRAMING

Tracking Mode:	Auto Framing
Tracking Effect:	Smooth
Tracking Speed:	Slow
Mirror:	<input type="checkbox"/>
Powerline Frequency: (Anti Flicker)	50Hz
HD:	<input checked="" type="checkbox"/>
WDR:	<input type="checkbox"/>
	<input type="range" value="7"/>

UI Element	Description
Tracking Effect	In Auto Framing mode the camera is framed to fit all participants in the view (if possible). The camera will automatically zoom in or out depending on the movement of participants.
Tracking Effect	Smooth: In smooth tracking the camera tracks in a smooth manner. Immediate: In immediate tracking the camera instantly switches to the best camera view.
Tracking Speed	In Smooth tracking mode the speed of the tracking can be adjusted to slow, medium, or fast tracking.
Mirror	Mirror flips the camera in the mirrored direction.
Powerline Frequency (Anti Flicker)	If there is flicker in the camera, typically caused by fluorescent light bulbs in the room, change the set frequency to the other one. (Options are 50Hz or 60Hz)
HD	Off decreases the quality of the camera to ensure laptop compatibility; On increases the quality to HD.
WDR	Adjusts wide dynamic range to improve the camera's image quality under high-contrast lighting conditions.

TRACKING MODE: SPEAKER TRACKING

Tracking Mode:

Mirror:

Powerline Frequency: (Anti Flicker)

HD:

WDR:

UI Element	Description
Tracking Effect	In Speaker Tracking mode the camera frames the location of the person talking, depending on which microphone picks up the person. For example, a person talking to the left of the camera will have the camera face that person, and when a person to the right of the camera speaks, the camera will pan to frame that person in the view.
Tracking Effect	Smooth: In smooth tracking the camera tracks in a smooth manner. Immediate: In immediate tracking the camera instantly switches to the best camera view.
Tracking Speed	In Smooth tracking mode the speed of the tracking can be adjusted to slow, medium, or fast tracking.
Mirror	Mirror flips the camera in the mirrored direction.
Powerline Frequency (Anti Flicker)	If there is flicker in the camera, typically caused by fluorescent light bulbs in the room, change the set frequency to the other one. (Options are 50Hz or 60Hz)
HD	Off decreases the quality of the camera to ensure laptop compatibility; On increases the quality to HD.
WDR	Adjusts wide dynamic range to improve the camera's image quality under high-contrast lighting conditions.

TRACKING MODE: PRESENTER TRACKING

Tracking Mode:

Mirror:

Powerline Frequency: (Anti Flicker)

HD:

WDR:

UI Element	Description
Tracking Effect	In Presenter Tracking mode the camera frames the location of the presenter. This is typically used for a single presenter. Note: there are no adjustments for smooth or speed of the framing in this mode.
Mirror	Mirror flips the camera in the mirrored direction.
Powerline Frequency (Anti Flicker)	If there is flicker in the camera, typically caused by fluorescent light bulbs in the room, change the set frequency to the other one. (Options are 50Hz or 60Hz)
HD	Off decreases the quality of the camera to ensure laptop compatibility; On increases the quality to HD.
WDR	Adjusts wide dynamic range to improve the camera's image quality under high-contrast lighting conditions.

Settings Page

GENERAL SETTINGS

The screenshot shows the 'Settings' page for the HT-CALIPSO device. The page is divided into sections: 'General Settings', 'IP Settings', and 'IP Conflict Detection'. Under 'General Settings', the 'Device Name' is set to 'HT-CALIPSO'. A note states: 'The device name must be 1 to 20 characters long (letters, numbers, "_" or "-" only). Note: Changing the device name will modify the SSID at the same time, and the Type-C Dongle needs to re-pairing.' There is an 'Apply' button below. Under 'IP Settings', the 'IP Method' is set to 'DHCP'. The 'IP Address' is '10.20.0.162', 'Subnet' is '255.255.255.0', and 'Gateway' is '10.20.0.1'. A note states: 'Note: LAN Module will automatically reboot after changing Network setting.' There is an 'Apply' button below. Under 'IP Conflict Detection', the 'IP Conflict Detection' toggle is turned on.

UI Element	Description
Device Name	Change the device name if desired. This name also acts as the name of soft AP and the receivers of AirPlay and Miracast. Note: The name must be 1~20 characters in length, including letters, numbers, “_” or “-”. By default, it is set as HT-CALIPSO .
IP Method	Select the desired IP mode between DHCP and Static. (Default is DHCP)
IP Address	Set the IP address manually if Static mode is selected.
Subnet	Set Subnet Mask manually if Static mode is selected.
Gateway	Set gateway address manually for the device to communicate with another network that uses different communication protocols when Static mode is selected.
Apply	Click to apply setting changes. Note: After the IP settings are changed, please refresh the Web UI page to re-login.
IP Conflict Detection	In DHCP mode this ensures the HT-CALIPSO will not select the same IP address as another device on the network.

VIDEO SETTINGS

The screenshot shows the 'Settings' page for HT-CALIPSO. Under 'Video Settings', there are three sections: 'Output', 'CEC', and 'CEC Test'. The 'Output' section has three dropdown menus: 'Timing' (set to 'Auto'), 'HDCP' (set to 'Passthrough'), and 'Screen' (set to 'Single Screen'). The 'CEC' section has a 'CEC' toggle switch (checked), 'One Touch Play' (set to '80 04'), and 'Standby' (set to '80 36'). Below these are 'Apply' and 'Load Default' buttons. The 'CEC Test' section has 'One Touch Play' and 'Standby' buttons. A note states: 'CEC command just supports Hex format with a maximum of 15 byte (example: 40 04)'.

UI Element	Description
Output Timing	<p>Set the output resolution for HDMI Out. Two operation methods are offered.</p> <ul style="list-style-type: none"> Auto: select to output the maximum resolution supported by display based on the display's EDID. E.g. If display supports up to 4K@30Hz, the device outputs 4K@30Hz. Resolution range list: select a desired output resolution from the drop-down menu to output this fixed resolution. <p>By default, it's set as Auto.</p>
Output HDCP	<p>Set the HDCP capability for HDMI Out and HDBT Out.</p> <ul style="list-style-type: none"> Follow: Set the output HDCP of HDMI Out to follow the HDCP capability of the video input. HDCP 2.2 or 1.4: Set the output HDCP of HDMI Out to HDCP 2.2 or 1.4. <p>By default it is set as Follow.</p>
Screen	<p>By default, the output screen is set to single screen. If two sources are connected such as a laptop and a mobile device the setting Split Screen can be selected to show both sources side by side.</p>
CEC	<p>Click to enable/disable CEC control on display. Default setting: Enable</p>
One Touch Play	<p>The display will turn on with the correct CEC command when a source is connected to HT-CALIPSO.</p>
Standby	<p>The display will turn off with the correct CEC command when the HT-CALIPSO goes into standby mode.</p>
Apply	<p>Click to apply setting changes.</p>
CEC Test	<p>Used to test the code entered for One Touch Play or Standby.</p>

WI-FI SETTINGS

HALL
TECHNOLOGIES

HT-CALIPSO

Overview Camera **Settings** Support

Wi-Fi Settings

Built-in WiFi

Band: 5G 2.4G

Channel: Auto Manual

48

Apply

Soft AP

Soft AP:

Soft AP Router:

Password: 12345678

The password must be 8 to 20 characters long (letters, numbers, "_" or "-" only)

Apply

UI Element	Description
Band	<ul style="list-style-type: none"> 5G: Configure the device's frequency band as 5GHz. 2.4G: Configure the device's frequency band as 2.4GHz. <p>By default, the device works at 5GHz. If your wireless devices don't support 5GHz, configures the frequency band as 2.4G before connecting them to the device via Miracast.</p>
Channel	By default, the Channel is set to Auto. If a different wireless channel is desired, uncheck Auto and select the desired channel.
Soft AP	Click to enable/disable the switcher's soft AP function.
Soft AP Router	<ul style="list-style-type: none"> Enable: Enable the device's soft AP router function so that wireless devices connected to soft AP can access the internet (in the condition that the LAN port of the device is connected to the internet). Disable: Disable the device's soft AP function to prevent wireless devices connected to soft AP from accessing the internet. <p>Note:</p> <p>(1) Before you use this feature, ensure the soft AP function is enabled.</p> <p>When the device's IP mode is set as Static, you must configure the LAN port's gateway and DNS correctly so that soft AP router runs properly.</p>
Soft AP Password	Configure soft AP password. Note: The soft AP password must be 8~20 characters in length, including letters, numbers, "_" or "-".
Apply	Click to apply setting changes.

BYOD SETTINGS

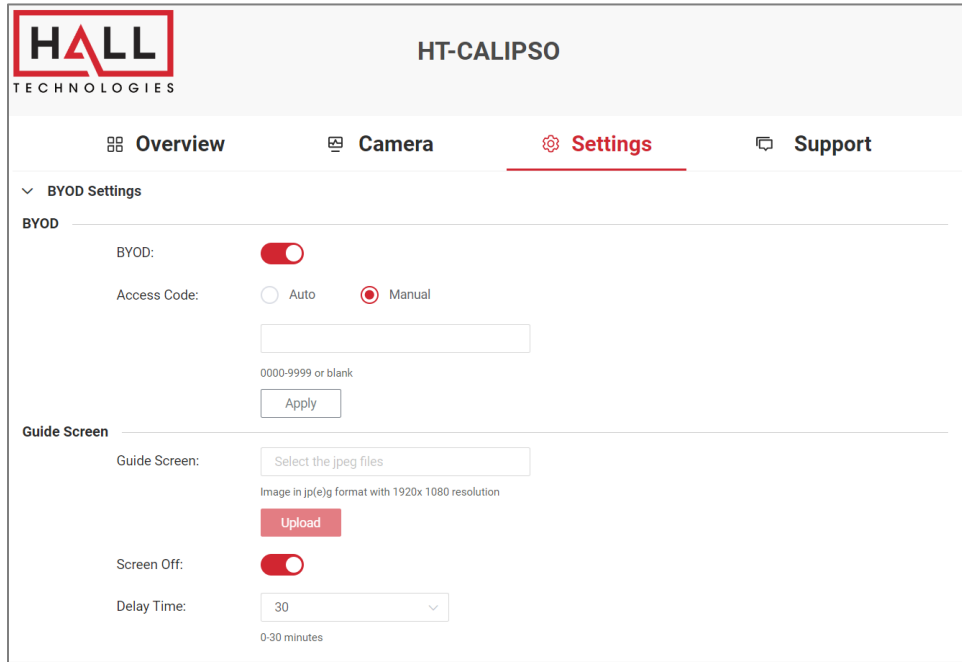

UI Element	Description
BYOD	<ul style="list-style-type: none"> On: Enable the device’s BYOD feature. Off: Disable the device’s BYOD feature. <p>Note: This feature is available for AirPlay and Miracast, not for HT-VOYAGER.</p>
Access Code	<p>Enter a four-digit access code to help prevent users from accidentally connecting to an unintended device and protect from unauthorized access.</p> <ul style="list-style-type: none"> When an access code is configured, it appears on the upper right corner of the display. If you don’t want to set access code, you can leave this blank. <p>By default, it is set as blank.</p>
Apply	Click to apply setting changes.
Guide Screen	Set a new picture for the Guide Screen.
Upload	Click to upload the picture file to the device. Note: The picture must be in jpeg format that has 1920 x 1080 pixels.
Screen Off	<p>Off: the OSD will remain on</p> <p>On: the OSD will remain on until the delay time setting is reached, and then it will go into standby mode.</p>
Delay Time	Set the delay time before the screen automatically turns off (Screen Off must be turned on)

SYSTEM SETTINGS

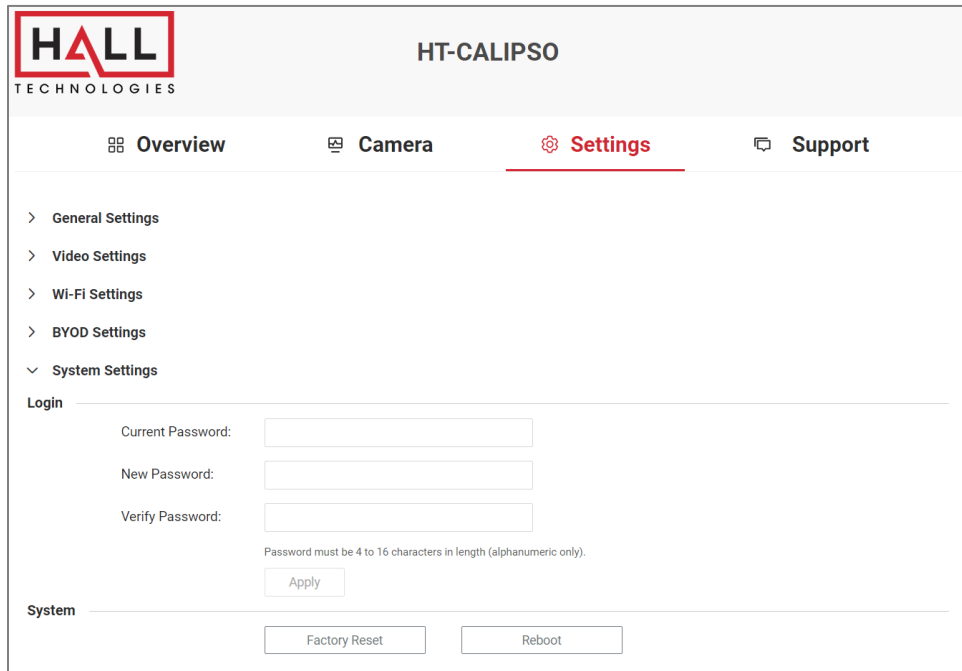

UI Element	Description
Current Password	To change to a new password, enter in the current password (default is admin).
New Password	Set a new login password.
Verify Password	Note: The new password must be 4 to 16 characters in length, alphanumeric only.
Apply	Click to apply setting changes.
Factory Reset	Click to restore the HT-CALIPSO to its factory defaults. You can also perform this task by sending the correct API command (see the HT-CALIPSO API Command document).
Reboot	Click to restart the HT-CALIPSO.

Support Page

DEVICE INFO & FIRMWARE UPDATE

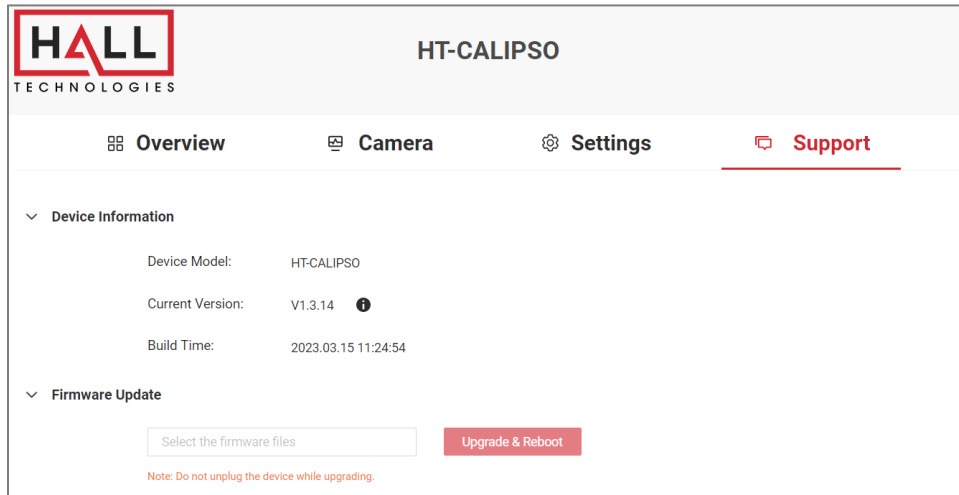

UI Element	Description
Device Information	Displays the device model, current version of firmware, and build time.
Firmware Update	Click in the field and browse for the local upgrade file for the firmware upgrade. The file will be a .gz file.
Upgrade & Reboot	Click to apply the upgrade file to the device. Note: The upgrade file is a .zip archive. After the upgrade file is uploaded completely, the device reboots.

API Commands

Additional commands not found in the Web GUI such as AEC enable/disable, AGC enable/disable, ANC enable/disable, and others can be found in the HT-CALIPSO API Commands document.

Troubleshooting

Problem Type	Problem	Options
Video	No Video on Display	<p>Confirm the HDMI input on the display is correctly selected</p> <p>Confirm the connected source is sending video to the HT-CALIPSO (verify the connected laptop is in duplicate or extend mode)</p>
	Choppy video using AirPlay	Make sure the AirPlay device's WiFi is connected to HT-CALIPSO's soft AP (may need to turn on in Web UI)
USB	USB-C not connecting	<p>Verify connected cable supports USB-C</p> <p>The response time to output video of USB 3.0 and Type-C is typically 6-8 seconds, although the response time between PC's can differ</p> <p>Confirm the PC can transmit video over USB-C by installing the DisplayLink device driver: https://www.displaylink.com/downloads</p>
	PC charge reminder pop-up	<p>This pop-up is normal since the HT-CALIPSO charging power might be different than what the laptop requires</p> <p>To ensure the laptop doesn't lose power, connect a dedicated power supply</p>
Audio	No audio at far end on soft codec call (i.e. Meet, Teams, Zoom, etc.)	<p>Verify the HT-CALIPSO microphone is not muted (red LED means muted)</p> <p>Verify the microphone selected in the soft codec is the HT-CALIPSO</p> <p>Verify the soft codec microphone is not muted</p>
	No audio heard on HT-CALIPSO	<p>Verify the HT-CALIPSO is selected as the desired speaker output in the laptop by clicking on the speaker icon to open the audio output</p> <p>Verify the HT-CALIPSO is not muted</p> <p>Verify the levels are turned up on both the laptop and the HT-CALIPSO</p>

Specifications

Audio and Video	
Interface	1 x HDMI in, 1 x HDMI out, 1 x USB-C, 1 x USB-B, 1 x USB-A, 1 x Mic, 1 x RJ45, 1 x DC
Video Resolutions	3840x2160@30Hz 8bit 4:4:4 (Max)
Output Video Encoding	MJPEG/YUY2/H.264/H.265 UVC 1.1

Camera and Sensor	
Lens	Fixed Focus
Sensor	1/2.5", CMOS, Effective Pixel: 8.0M
White Balance	Auto
Backlight Compensation	Auto
Digital Noise Reduction	2D, 3D Digital noise reduction supported
Viewing Angle	FOV: 120°
ePTZ	Supported 5 x Digital Zoom
HDR	Supported
Tracking Mode	Auto Framing / Speaker Tracking / Presenter Tracking

Speakerphone	
Microphone	4 x Linear microphone arrays with echo cancellation Pick-up Range: 5m/16.4ft~8m/26.2ft
Speaker	2 x 5 W

Communication and Control	
HDMI	HDMI 2.0, HDCP 2.2
USB	USB-C: USB 3.0 host (60W max charging) USB-A: USB 3.0 device USB-B: USB 3.0 host
USB Protocol	UAC, UVC, USB HID
Ethernet	1 x RJ-45
WLAN	IEEE 802.11 a/b/g/n/ac
Control Method	Web UI, Bluetooth Remote Controller

General	
Operating Temperature	0°C ~ 40°C (32°F to 104°F), 10% to 90%, non-condensing
Storage Temperature	-20°C ~ 60°C (-4°F to 140°F), 10% to 90%, non-condensing
MTBF	> 30000h
Power Supply	DC 24V 5A
Power Consumption (Max)	100W
Dimension (Width x Height x Depth)	700mm x 126.83 mm x 90mm/27.56" x 4.99" x 3.54" (with Bracket)
Net Weight	2.42kgs/5.324lbs (with Bracket)
Gross Weight	6.22kgs/13.68lbs



© Copyright 2022. Hall Technologies
All rights reserved.

1234 Lakeshore Drive, Suite #150, Coppell, TX 75019
halltechav.com / support@halltechav.com
(714)641-6607