



Hall Technologies • 1234 Lakeshore Dr Suite #150 Coppell, TX 75019 • halltechav.com

DSCV-70-RX

HDBaseT 2.0 Receiver with USB and Audio De-embedding

User Manual

Version: V1.0.0



Important Safety Instructions

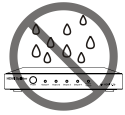

1. Do not expose this apparatus to rain, moisture, dripping or splashing and that no objects filled with liquids, such as vases, shall be placed on the apparatus.



2. Do not install or place this unit in a bookcase, built-in cabinet or in another confined space. Ensure the unit is well ventilated.



3. To prevent risk of electric shock or fire hazard due to overheating, do not obstruct the unit's ventilation openings with newspapers, tablecloths, curtains, and similar items.



4. Do not install near any heat sources such as radiators, heat registers, stoves, or other apparatus (including amplifiers) that produce heat.



5. Do not place sources of naked flames, such as lighted candles, on the unit.



6. Clean this apparatus only with dry cloth.



7. Unplug this apparatus during lightning storms or when unused for long periods of time.

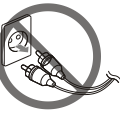

8. Protect the power cord from being walked on or pinched particularly at plugs.



9. Only use attachments / accessories specified by the manufacturer.



10. Refer all servicing to qualified service personnel.

Table of Contents

Introduction	4
Overview	4
Features	4
Package Contents	5
Specifications	6
Panel Description	7
Front Panel	7
Rear Panel	8
Installation and Wiring	9
Installation	9
Wiring	10
RS232 Operation	12
Control the RS232-enabled Device	12
Control the Wall Plate Transmitter	Error! Bookmark not defined.

Overview

This product is an HDBT 2.0 receiver that is designed to work with an HDBT wall plate transmitter, reliably extending UHD video, multi-channel audio, USB 2.0, RS232 signal and power up to 40m/131ft using a single Cat 5e/6/6a/7 cable. With PSE module built-in, it can supply power to the transmitter with PD module via a single power supply.

It supports USB 2.0 pass-through, providing a solution for users who need remote control of PC resources sources such as keyboard, mouse, interactive display, or USB streaming devices over distance. The RS232 port allows bi-directional RS232 serial communication and firmware upgrade, the functions can be set via DIP switch.

Features

- Simple and cost-effective HDBT 2.0 receiver.
- HDMI 1.4 with 4K@60Hz (chroma sub-sampling 4:2:0 8-bit only) and HDCP 2.2 compliant.
- Transmits 4K@60Hz (YUV 4:2:0) signal up to 40m/131ft and 1080P@60Hz signal up to 70m/230ft via a Cat 6a/7 cable.
- Transmits 4K@60Hz (YUV 4:2:0) signal up to 35m/115ft and 1080P@60Hz signal up to 60m/197ft via a Cat 5e/6 cable.
- Supports analog audio pass-through from transmitter to receiver.
- Supports analog audio de-embedding for HDMI output.
- High-speed USB 2.0 pass-through over HDBT.
- Provide two high-current USB device ports to connect high-power USB device.
- Supports bi-directional RS232 serial communication to control a wall plate transmitter when paired with the wall-plate transmitter.
- Supports firmware upgrade through the RS232 port.
- Built-in PSE to power remote HDBT Wall plate transmitter with PD module.

Package Contents

- 1 x Receiver
- 1 x DC 12V Power Adapter with US, UK, EU, AU Pins
- 1 x Phoenix Male Connector (3.5mm, 3 Pins)
- 2 x Mounting Brackets (with Screws)
- 1 x User Manual

Specifications

Technical	
Input/Output Port	1 x HDBT IN, 1 x HDMI OUT, 1 x RS232, 2 x AUDIO OUT (One for De-embed and another one for Pass-through), 4 x USB DEVICE, 1 x DC 12V IN
Input Signal Type	HDBT 2.0
Output Signal Type	HDMI with 4K@60Hz 4:2:0 8 bit, HDCP 2.2
Input/Output Resolution Supported	<p>VESA: 800x600⁸, 1024x768⁸, 1280x768⁸, 1280x800⁸, 1360x768⁸, 1366x768⁸, 1440x900⁸, 1600x900⁸, 1600x1200⁸, 1680x1050⁸, 1920x1200⁸</p> <p>SMPTE: 1280x720P^{1,2,3,4,5,6,7,8}, 1920x1080I^{6,8}, 1920x1080P^{1,2,3,4,5,6,7,8}, 3840x2160^{2,3,5,6,8}, 4096x2160^{2,3,5,6,8}</p> <p>1 = at 23.98 Hz, 2 = at 24 Hz, 3 = at 25 Hz, 4 = at 29.97 Hz, 5 = at 30 Hz, 6 = at 50 Hz, 7 = at 59.94 Hz, 8 = at 60 Hz</p> <p>NOTE: 4096x2160/3840x2160@50Hz/60Hz is based on chroma sub- sampling 4:2:0 8-bit only.</p>
Maximum Pixel Clock	340MHz
Audio Format	<p>HDMI OUT: Supports multi-channel audio formats, including PCM 2.0/5.1/7.1, Dolby TrueHD, Dolby Atmos, DTS-HD Master Audio and DTS:X</p> <p>AUDIO OUT: Stereo</p>

General	
Operating Temperature	0°C to 45°C (32°F to 113°F)
Storage Temperature	-20°C to 70°C (-4°F to 158°F)
Humidity	10% to 90%, non-condensing
ESD Protection	Human-body Model: ±8kV (Air-gap discharge)/ ±4kV (Contact discharge)
Power Supply	DC 12V 3A
Power Consumption (Max)	8W (Without USB)
Device Dimension (W x H x D)	210mm x 25mm x 90.2mm/8.27" x 0.98" x 3.55"

General	
Product Weight	0.46kg/1.01lbs

Transmission Distance

Note: Straight-through category cable wired to T568B standard is recommended.

Cable Type	Range	Supported Video
Cat 5e/6	60m/197ft	1080p@60Hz, 36bpp
Cat 6a/7	70m/230ft	
Cat 5e/6	35m/115ft	4K@30Hz 4:4:4, 24bpp
Cat 6a/7	40m/131ft	4K@60Hz 4:2:0, 24bpp

Panel Description

Front Panel

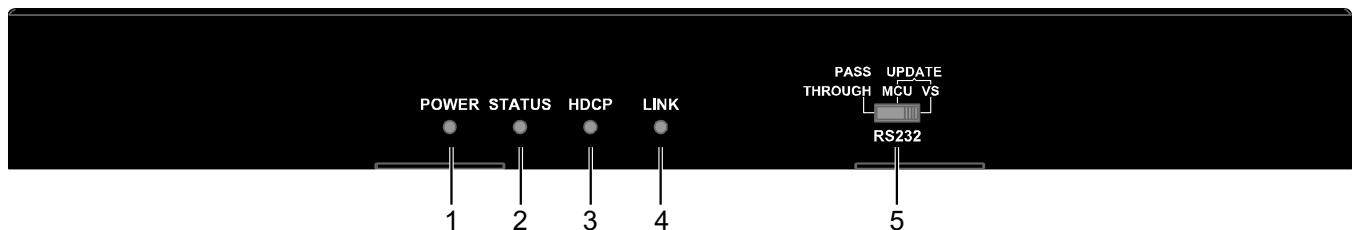

ID	Name	Description
1	POWER LED	On: The device is powered on. Off: The device is powered off.
2	STATUS LED	Blinking: The device is working properly. Off: The device is not working properly.
3	HDCP LED	On: HDCP protected content is being transmitted. Blinking: Non-HDCP protected content is being transmitted. Off: No content is being transmitted.
4	LINK LED	On: HDBT link is normal. Blinking/Off: Link error or no link.

ID	Name	Description
5	RS232 DIP Switch	<p>Set the function of RS232 port.</p> <p>PASS-THROUGH (Default) : RS232 port is used to RS232 commands pass-through over HDBT.</p> <p>MCU: RS232 port is used to update its MCU firmware.</p> <p>VS: RS232 port is used to update Valens firmware of transmitter and receiver.</p>

Rear Panel

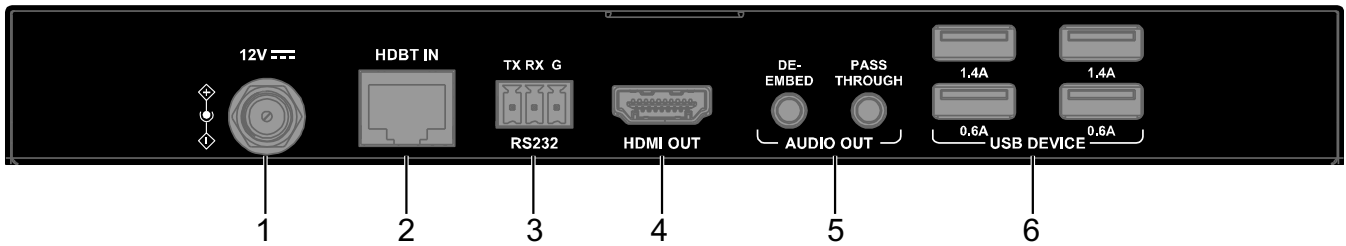

ID	Name	Description
1	12V	Connect to the DC 12V power adapter provided.
2	HDBT IN	Connect to HDBT OUT of the transmitter via a Cat 5e/6/6a/7 cable. With PoH OUT, the receiver can supply power to the connected transmitter with PD module.
3	RS232	For RS232 pass-through or firmware upgrade and can be set through DIP switch on front panel.
4	HDMI OUT	Connect to an HDMI display.
5	AUDIO OUT	<p>Unbalanced stereo audio output.</p> <ul style="list-style-type: none"> PASS-THROUGH: For audio pass-through from Audio IN port on the transmitter to this port. DE-EMBED: For audio de-embedding from the HDMI output.

ID	Name	Description
6	USB DEVICE	Connect to USB devices (e.g., keyboard, mouse, USB camera, USB flash drive, etc.). Note: USB ports support the USB 2.0 standard with a maximum of 1.4A for the top two ports and 0.6A on the bottom two ports. Before connecting a USB 3.0 device, ensure it is compatible with USB 2.0.

Installation and Wiring

Installation

Note:

- Before installation, please ensure the device is disconnected from the power source.
- During wiring, connect and disconnect the cables gently.
- The height of installation should not exceed 2 meters from the ground.

Steps to install the device in a suitable location:

1. Attach the installation bracket to the enclosure using the screws provided in the package separately.
2. The bracket is attached to the enclosure as shown.

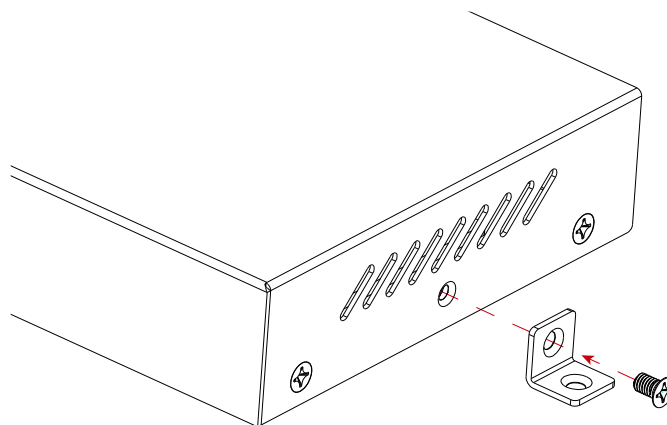

3. Repeat steps from 1 to 2 for the other side of the unit.
4. Attach the brackets to the surface you want to hold the unit against using the screws (provided by others).

Wiring

Warnings:

- Before wiring, disconnect the power from all devices.
- During wiring, connect and disconnect the cables gently.

Steps for device wiring:

1. Connect HDBT OUT of the wall-plate transmitter to HDBT IN of the receiver via a Cat 5e/6/6a/7 cable.
2. Connect an HDMI display (e.g., TV, LED/LCD display, projector, etc.) to HDMI OUT of the receiver.
3. Connect audio devices (e.g., earphone, speaker) to De-embed and Pass-through ports of the receiver.
4. Connect USB Devices to USB DEVICE of the receiver.
5. Connect the provided power adapter to the receiver, with PoH function, the receiver can supply power for the wall-plate transmitter with PD module.
6. Connect video and audio sources to the wall-plate HDBT transmitter.
7. Connect a USB Host device to USB port of the transmitter.
8. Power on all devices.

- Cat x — USB — HDMI Out
- USB-C — Audio Out

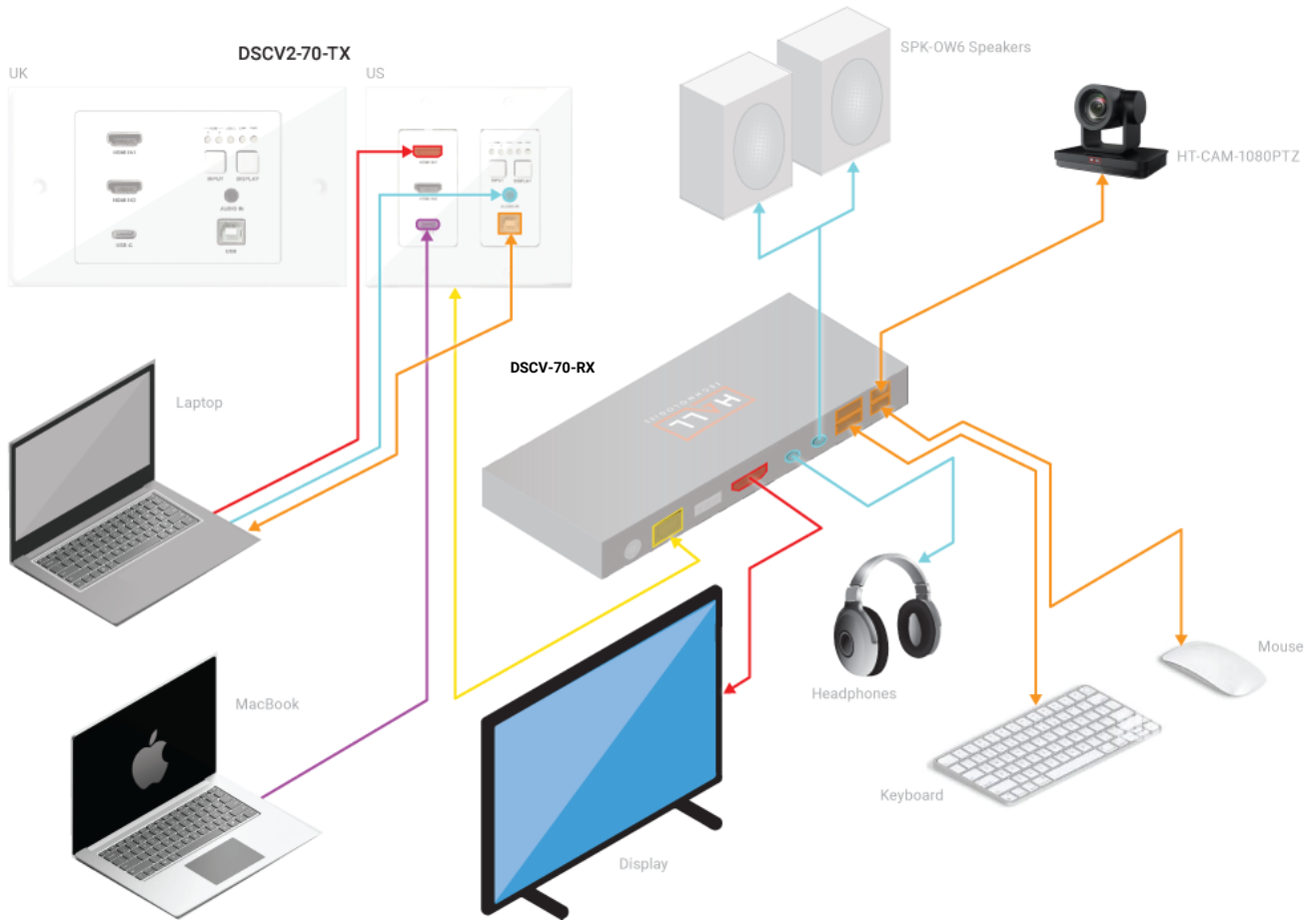

RS232 Operation

The receiver provides a RS232 port that allowing for RS232 bi-directional serial communication. Set the DIP switch of the receiver to the position of “PASS-THROUGH”, you can control a RS232-enabled device connected to receiver at transmitter side or control the transmitter by a control system at receiver side through serial communication.

Control the RS232-enabled Device

1. Set the DIP switch of the device to the position of “PASS-THROUGH”.
2. Connect a RS232-enabled device (e.g., a projector) to RS232 of the receiver.
3. Connect HDBT IN of the receiver to HDBT OUT of an HDBT transmitter.
4. Connect a RS232 enabled device such as a PC to the transmitter.
5. When all is set, serial commands can be preset to the transmitter through the connected PC, and the transmitter can send the preset commands to the connected projector of the receiver to control it.

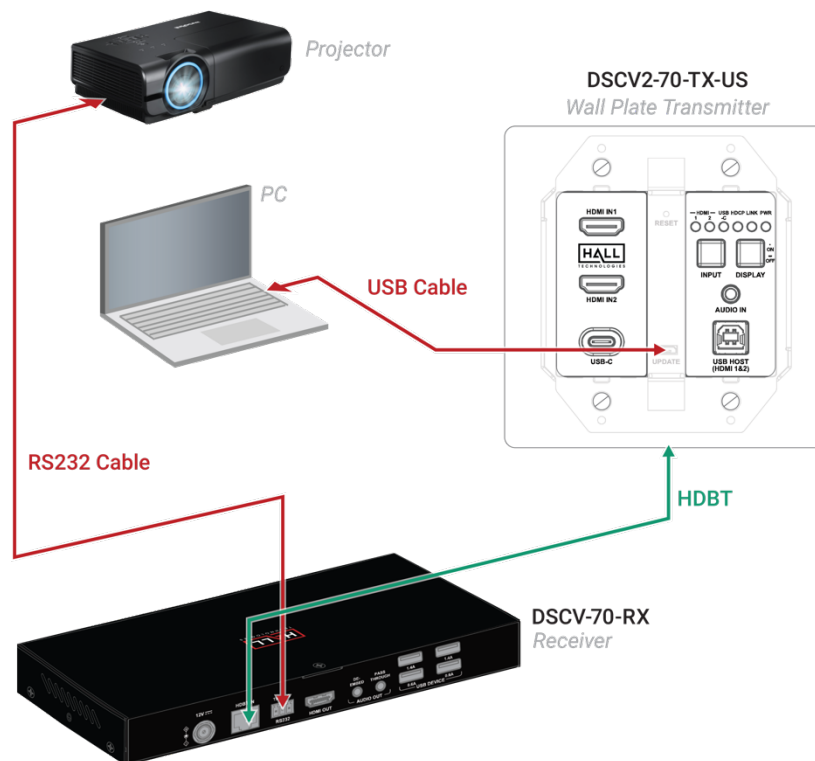

Control the Wall Plate Transmitter

1. Set the DIP switch of the device to the position of "PASS-THROUGH".
2. Connect a control system to RS232 port of the receiver.
3. Connect HDBT IN of the receiver to HDBT OUT of the wall plate transmitter.
4. When all settings are completed, serial commands can be transmitted between the control system and the transmitter for controlling and configuring the transmitter.

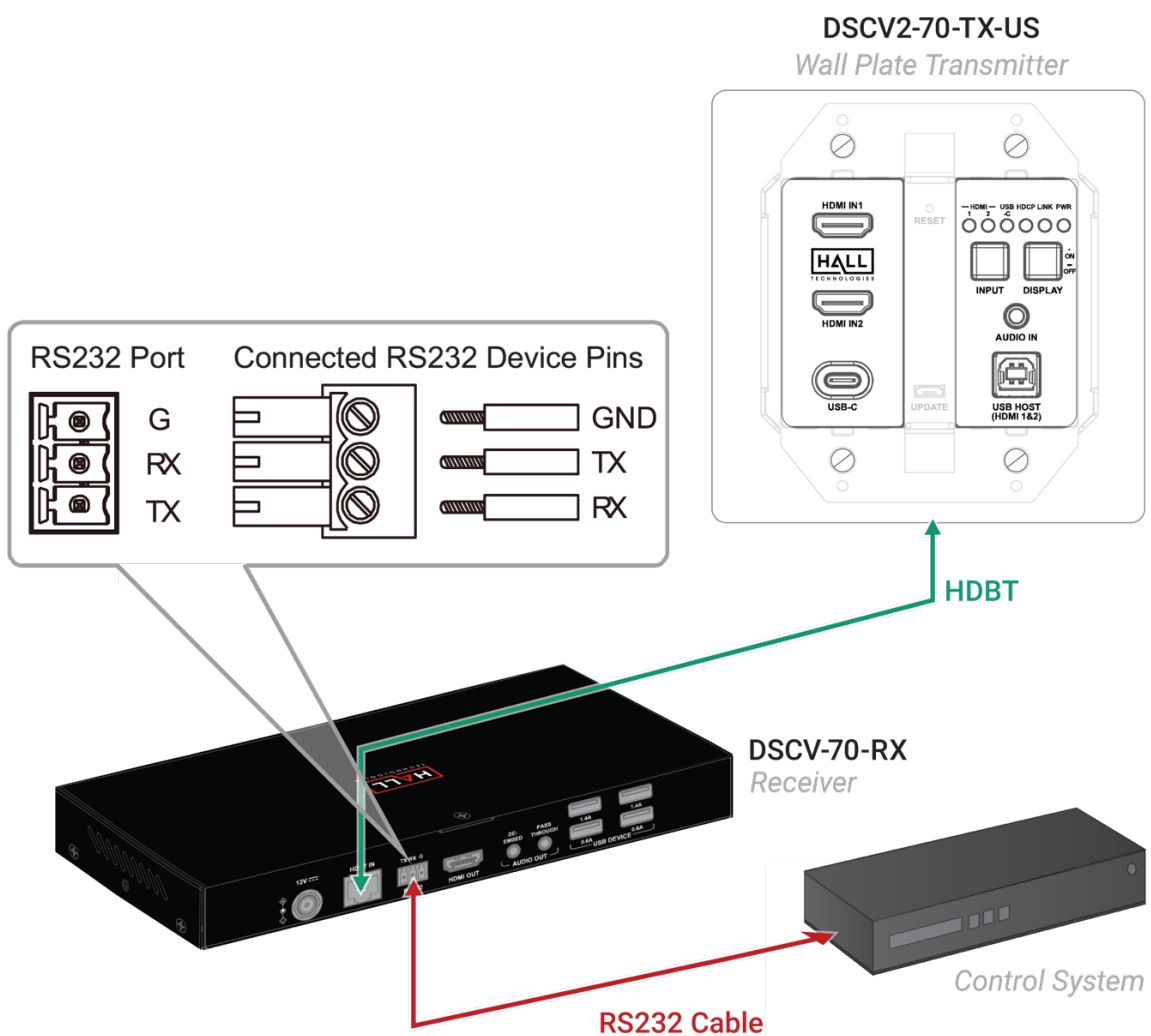



© Copyright 2022. Hall Technologies
All rights reserved.

1234 Lakeshore Drive, Coppell, TX 75019
halltechav.com / support@halltechav.com
(714)641-6607